

Beacon

A clean, modern design that provides soft, even illumination. It's horizontal or vertical mounting position, three sizes and various options give it the versatility to adapt to any situation from indoor to outdoor and commercial to residential.



Simple and Versatile

Highly efficient and carefully engineered, the Beacon is built to withstand years of use.

Product Highlights

- Assembled in Ohio
- Three sizes: 18", 34" & 45"
- 3000K, 3500K, 4000K & 5000K color temperatures
- 0-10V and phase (leading or trailing edge) dimming
- Emergency battery available
- Horizontal or vertical mounting











TERONLIGHTING.COM



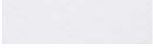

The Beacon line

Finishes

-  Antique Copper
-  Antique Silver
-  Bronze Mist
-  Textured Black
-  Textured Bronze
-  Textured White
-  Matte Silver
-  Sand
-  Swedish Steel

Sealed with o-rings, extruded aluminum.

Impact resistant, UV stabilized extruded acrylic.

Impact resistant, heavy gauge heat treated aluminum, fully gasketed, horizontal and vertical mounting.



Beacon



Beacon is a series of LED luminaires with modern lines and diffuse illumination. With three sizes, multiple color temperatures, flexible dimming control and positional flexibility, its versatility makes it ideal for a broad range of applications whether they be indoor or outdoor, commercial or residential. Its fully gasketed mounting plate and o-ring sealed end caps result in a wet location rating to keep water at bay in either a vertical or horizontal mounting position. High quality polyester powder coating, heavy gauge heat treated aluminum and stainless steel fasteners combine with the impact resistant, UV stabilized, matte white acrylic diffuser to provide both durability and performance. It is easily and quickly installed using the mounting plate to either a 4" octagonal junction box or with wall anchors, no disassembly is required. Tamper resistant, stainless steel hardware is standard to ensure Beacon remains in place providing high quality lighting for years to come.

Sizing

| PRODUCT | A | B | C |
|---------|-------|-------|------|
| BCN18 | 9.4" | 18.3" | 4.0" |
| BCN34 | 21.3" | 34.0" | 4.0" |
| BCN45 | 21.3" | 45.4" | 4.0" |

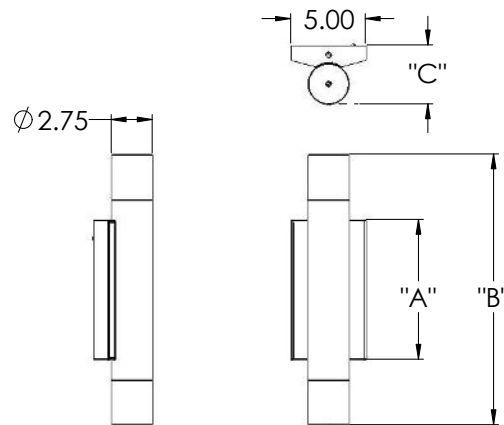

| PRODUCT | "A" | "B" | "C" |
|---------|-------|-------|------|
| BCN18 | 9.4" | 18.3" | 4.0" |
| BCN34 | 21.3" | 34.0" | 4.0" |
| BCN45 | 21.3" | 45.4" | 4.0" |

Certifications

- Wet location rated
- ADA Compliant
- Buy America Compliant

Options

- Integral EM battery (not ADA compliant)
- Fusing
- Surge protection

Mounting

- Horizontal or vertical
- Fully gasketed mounting plate
- No disassembly required for installation

LED Performance

- L70 calculated life: 100,000 + hours
- 3-step Macadam color binning
- 3000K, 3500K, 4000K & 5000K CCT

LED Driver

- Driver is constant current, Class 2, 120-277 Vac, 50/60Hz
- Operating ambient temperature: -40°C / -40°F to 50°C / 122°F
- 0-10V and phase (leading or trailing edge) dimming

Customization

- Custom color
- Custom CCT
- RGB or filters