

# TURNBERRY MSI LED 26"

Architectural Indoor



PROJECT:	
TYPE:	
PO#:	QTY:
COMMENTS:	



## FEATURES

- [Internal Motion Sensor](#)
- Die-Formed Steel Housing w/ Textured White Polyester Powder Coat Finish
- Die Cast Aluminum End Caps w/ Textured White Polyester Powder Coat Finish
- High Impact White Acrylic Diffuser (50% DR Acrylic) w/ Inner Frosted Diffuser
- Aluminum LED Mounting Plate
- Recessed Screws
- Fixture Mounts Directly to Surface w/ Two Wall Anchors (Not Included)
- 120V - 277V
- Surge Protector
- ADA Compliant
- CSA Listed Damp Location For Wall or Ceiling Mount
- Emergency Driver Available
- LED Light Fixture

## LINE DRAWING

LINE DRAWING NOT TO SCALE

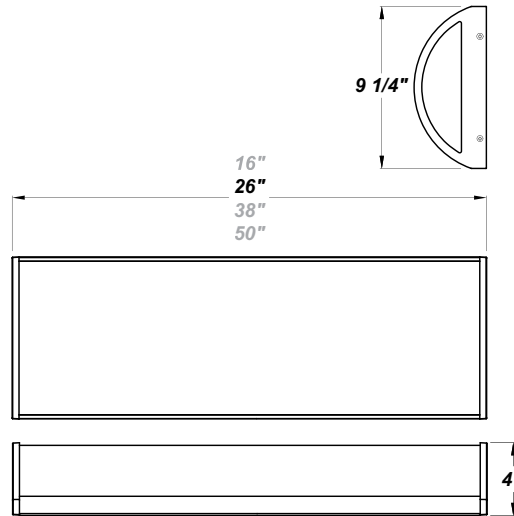

## FINISHES

Antique Copper



Antique Silver



Bronze Mist



Matte Silver

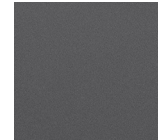

Sand

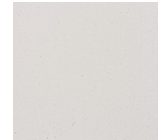

Swedish Steel

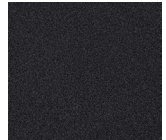

Textured Black

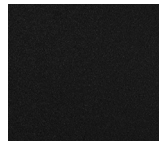

Textured Bronze

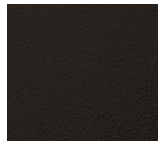

Textured White

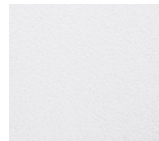

For RAL Colors & Custom Match - Contact Teron Lighting Inc.

# TURNBERRY MSI LED 26"

Architectural Indoor



Fixture Core

PROJECT:	
TYPE:	
PO#:	QTY:
COMMENTS:	

PRODUCT CODE	SOURCE/WATTAGE	VOLTAGE	DIMMING DRIVER
TRN24 - Turnberry 26"	<b>L24.0-ZE700</b> - 24.0W LED Strip(s) @ 700mA Line Voltage 4-Wire Dimming Driver (Dimmable 0 - 10V) ** <b>L30.0-ZE900</b> - 30.0W LED Strip(s) @ 900mA Line Voltage 4-Wire Dimming Driver (Dimmable 0 - 10V) ** <b>L34.0-ZE1000</b> - 34.0W LED Strip(s) @ 1000mA Line Voltage 4-Wire Dimming Driver (Dimmable 0 - 10V) **	<b>120-277V</b> (50 / 60Hz)	<b>Not Applicable</b>
ORDER INFO			
TRN24	L19.0-ZE600	120-277V	Not Applicable

Example ^ (may not represent a manufacturable product)

Aesthetics & Options

TRIM	FINISH	COLOR TEMP	OPTIONS
<b>Not Applicable</b>	<b>AC</b> - Antique Copper <b>TB</b> - Textured Black <b>AS</b> - Antique Silver <b>BZ</b> - Textured Bronze <b>BT</b> - Bronze Mist <b>TW</b> - Textured White (Standard) <b>SM</b> - Matte Silver <b>SN</b> - Sand <b>SW</b> - Swedish Steel	<b>30K</b> - 3000K Color Temp <b>35K</b> - 3500K Color Temp <b>40K</b> - 4000K Color Temp <b>50K</b> - 5000K Color Temp	<b>EB5</b> - Keystone KT-EMERLED-5-500 Integral 5W LED Driver <b>F</b> - Fused <b>MSI</b> - Steinel HFLUM2-WR Internal Motion Sensor <b>OEL</b> - Single End Window <b>TEL</b> - Twin End Windows (Both Ends) <b>TP</b> - Tamper Resistant Screws
ORDER INFO			
Not Applicable	AC	30K	EB5

Example ^ (may not represent a manufacturable product)

PROD	SOURCE	30K SPECS				
TRN24	L24.0	<ul style="list-style-type: none"> <li>30K - 3000K Color Temp</li> <li>3795 LED Source Lumens</li> <li>158.1 LED Source Lumens Per Watt</li> </ul>				
	L30.0	<ul style="list-style-type: none"> <li>30K - 3000K Color Temp</li> <li>4879 LED Source Lumens</li> <li>162.6 LED Source Lumens Per Watt</li> </ul>				
	L34.0	<ul style="list-style-type: none"> <li>30K - 3000K Color Temp</li> <li>5421 LED Source Lumens</li> <li>159.4 LED Source Lumens Per Watt</li> </ul>				

REPLACEMENT PART	PART NO	NOTES
2' Acrylic LED Lens Assembly	38216	** EB Option Available
Frosted Polycarbonate End Diffuser (For OEL / TEL)	3410862	

Don't see the configuration you are looking for?  
Call us today at (513) 858-6004



TERONLIGHTING.COM  
 33 DONALD DR, FAIRFIELD, OH 45014  
 P: 513.858.6004 F: 513.858.6038  
 E: SALES@TERONLIGHT.COM



We reserve the right to revise the design components of any product due to parts availability or change in UL standards, without assuming any obligation or liability to modify any products previously manufactured, and without notice.