

EAGLE LED 11"

Architectural Outdoor



PROJECT:	
TYPE:	
PO#:	QTY:
COMMENTS:	

FEATURES

- ADA Compliant
- Energy Star Listed
- Steel Mounting Pan w/ Hi-Reflectance White Powder Coat Finish
- Luminous White Acrylic Diffuser
- Mounts Directly to 4" Junction Box (By Others)
- IES Files Available
- CSA Listed Damp Location Wall and Ceiling
- LED Light Fixture
- L70 Life time for 60,000hr
- Mounting Hardware Included



LINE DRAWING

LINE DRAWING NOT TO SCALE

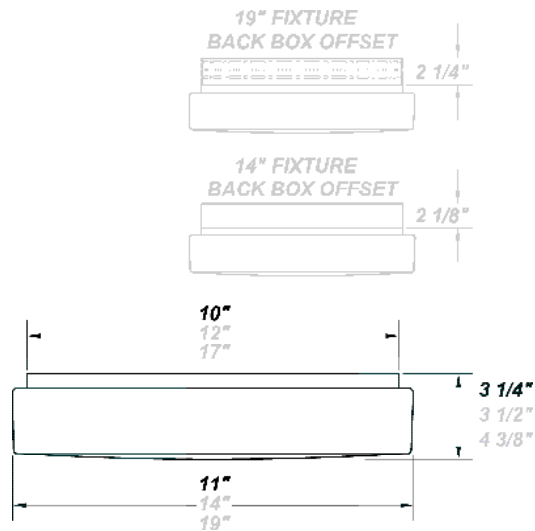

FINISHES

Antique Copper

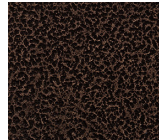

Antique Silver

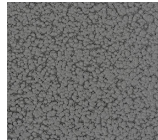

Bronze Mist



Gloss White

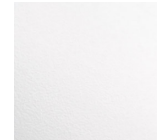

Matte Silver

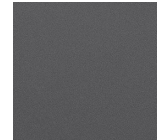

Sand



Swedish Steel

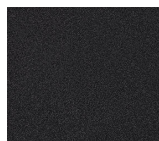

Textured Black

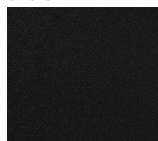

Textured Bronze

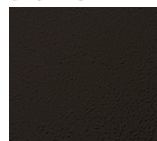

Textured White

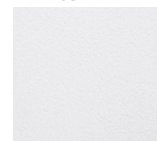

For RAL Colors & Custom Match - Contact Teron Lighting Inc.

EAGLE LED 11"

Architectural Outdoor



Fixture Core

PROJECT:	
TYPE:	
PO#:	QTY:
COMMENTS:	

PRODUCT CODE	SOURCE/WATTAGE	VOLTAGE	DIMMING DRIVER
EE11 - Eagle 11"	L13.5-ZE420 - (80) LED Array @ Line Voltage 4-Wire Dimming Driver (Dimmable 0 - 10V) L17.0-ZE530 - (80) LED Array @ Line Voltage 4-Wire Dimming Driver (Dimmable 0 - 10V)	120V 270V (50 / 60Hz)	ZE - 0-10V Dimming
ORDER INFO			

EE11	L13.5-ZE420	120-277V	ZE
Example ^ (may not represent a manufacturable product)			

Aesthetics & Options

TRIM	FINISH	COLOR TEMP	OPTIONS
Not Applicable	AC - Antique Copper AS - Antique Silver BT - Bronze Mist WH - Gloss White (Standard) SM - Matte Silver SN - Sand SW - Swedish Steel TB - Textured Black BZ - Textured Bronze TW - Textured White	30K - 3000K Color Temp 35K - 3500K Color Temp 40K - 4000K Color Temp 50K - 5000K Color Temp	ALP - Aluminum Mount Pan w/ White Finish F - Fused STC12-WH - 12" Stem and Canopy Kit STC24-WH - 24" Stem and Canopy Kit STC36-WH - 36" Stem and Canopy Kit STC48-WH - 48" Stem and Canopy Kit TP - Tamper-Proof Screw Set WLL - LED High Lumen Lens WPL - White Polycarbonate SPD - Surge Protection Device
ORDER INFO			

Not Applicable	AC	50K	ALP
Example ^ (may not represent a manufacturable product)			

PROD	SOURCE	30K SPECS	30K SPECS			
EE 11"	L13.5	<ul style="list-style-type: none"> • WAL Lens • 80 CRI Typ. • 3000K Color Temp • 2100 LED Source Lumens • 155.5 LED Source Lumens Per Watt • 1071 Delivered LED Lumens • 71.6 Delivered LED Lumens Per Watt 	<ul style="list-style-type: none"> • WLL Lens • 80 CRI Typ. • 3000K Color Temp • 2100 LED Source Lumens • 155.5 LED Source Lumens Per Watt • 1562 Delivered LED Lumens • 104.4 Delivered LED Lumens Per Watt 			
	L17.0	<ul style="list-style-type: none"> • WAL Lens • 80 CRI Typ. • 3000K Color Temp • 2650 LED Source Lumens • 157 LED Source Lumens Per Watt • 1364 Delivered LED Lumens • 73.2 Delivered LED Lumens Per Watt 	<ul style="list-style-type: none"> • WLL Lens • 80 CRI Typ. • 3000K Color Temp • 2650 LED Source Lumens • 157 LED Source Lumens Per Watt • 2065 Delivered LED Lumens • 110.7 Delivered LED Lumens Per Watt 			

REPLACEMENT PART	PART NO	NOTES
11" White Acrylic Diffuser	3011360	
11" White Acrylic LED Diffuser	3053060	
		Don't see the configuration you are looking for? Call us today at (513) 858-6004



TERONLIGHTING.COM
33 DONALD DR, FAIRFIELD, OH 45014
P: 513.858.6004 F: 513.858.6038
E: SALES@TERONLIGHT.COM



We reserve the right to revise the design components of any product due to parts availability or change in UL standards, without assuming any obligation or liability to modify any products previously manufactured, and without notice.