

CONCERTO DL LED

Architectural Indoor



PROJECT:	
TYPE:	
PO#:	QTY:
COMMENTS:	

FEATURES

- ADA Compliant
- Aluminum Fixture w/ Textured White Powder Coat Finish
- Aluminum Mounting Plate Mounts to Wall Surface (Centered Over And Attached to J-Box)
- CSA Listed Dry Location For Wall Mount
- Up Light or Down Light
- Dimmable @ 120V
- Dimmable to 0%
- Estimated Lumen Depreciation (TM-21) 69% of Initial Lumens (L70) @ 80,000 hours
- LEDs Are Lensed And Not Exposed
- LED Light Fixture
- Optional Surge Protector

LINE DRAWING

LINE DRAWING NOT TO SCALE

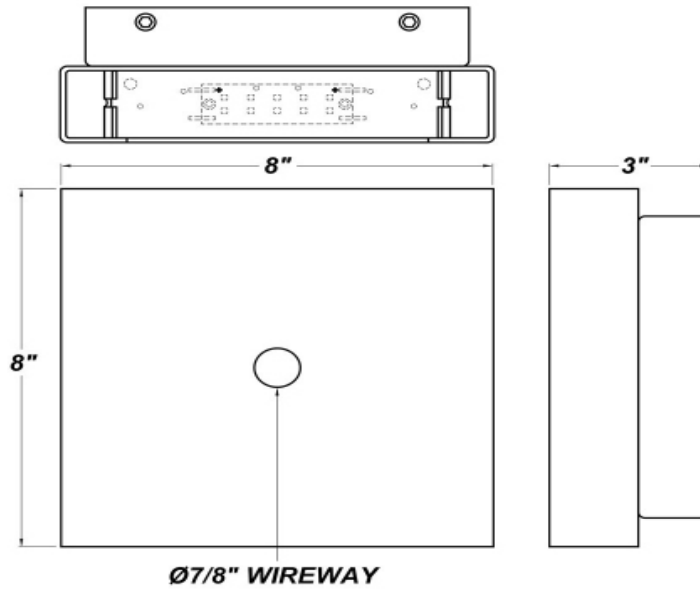

FINISHES

Antique Copper



Antique Silver

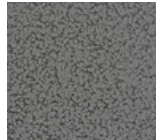

Bronze Mist

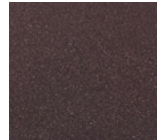

Matte Silver

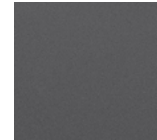

Sand

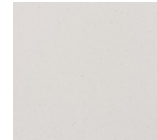

Swedish Steel

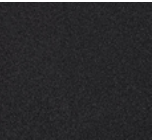

Textured Black



Textured Bronze

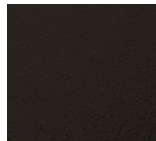

Textured White

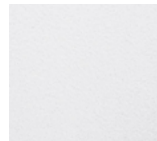

For RAL Colors & Custom Match - Contact Teron Lighting Inc.

CONCERTO DL LED

Architectural Indoor



Fixture Core

PROJECT:	
TYPE:	
PO#:	QTY:
COMMENTS:	

PRODUCT CODE	SOURCE/WATTAGE	VOLTAGE	DIMMING DRIVER
CTO - Concerto	L10.8-LT350 - 10.8W @350mA ELV Dimming Driver	120V 277V (50 / 60Hz)	See Source/Wattage
ORDER INFO			
CTO Example ^	L10.8-LT350	120V	See Source/Wattage

Aesthetics & Options

TRIM	FINISH	COLOR TEMP	OPTIONS
DL	AC - Antique Copper AS - Antique Silver BT - Bronze Mist SM - Matte Silver SN - Sand SW - Swedish Steel TB - Textured Black BZ - Textured Bronze TW - Textured White (Standard)	30K - 3000K Color Temp 35K - 3500K Color Temp 40K - 4000K Color Temp	S - Surge Protector
ORDER INFO			
DL Example ^	TW	30K	S

PROD	SOURCE	30K SPECS			
CTO DL	L10.8	<ul style="list-style-type: none"> 30K - 3000K Color Temp 672.5 Source Lumens on The Bottom 62.3 Source LED Lumens Per Watt on The Bottom 			

REPLACEMENT PART	PART NO	NOTES
		Darker Finishes May Reduce The LED Output. Textured White And Matte Silver Are Recommended for Maximum Light Output.
		Don't see the configuration you are looking for? Call us today at (513) 858-6004



TERONLIGHTING.COM
 33 DONALD DR, FAIRFIELD, OH 45014
 P: 513.858.6004 F: 513.858.6038
 E: SALES@TERONLIGHT.COM



We reserve the right to revise the design components of any product due to parts availability or change in UL standards, without assuming any obligation or liability to modify any products previously manufactured, and without notice.