

# GUARDIAN W TXT LED 38"

Architectural Outdoor



PROJECT:	
TYPE:	
PO#:	QTY:
COMMENTS:	

## FEATURES

- 120V - 277V, Plus 347V For Selected Wattages
- Aluminum Fascia w/ Matte Silver Polyester Powder Coat Finish
- Aluminum Reflector w/ Hi-Reflectance White Powder Coat Finish
- CSA Listed Wet Location Vertical Position Only
- CSA Listed Damp Location Horizontal Position
- Die Cast Aluminum End Caps w/ Matte Silver Polyester Powder Coat Finish
- Emergency Battery Available
- Extruded Aluminum Housing w/ Matte Silver Polyester Powder Coat Finish
- Fixture Mounts Directly to Surface w/ Two Wall Anchors (Not Included)
- High Impact White Acrylic Diffuser (50% DR Acrylic)
- LED Light Fixture
- Over-Voltage, Over-Current, and Short-Circuit Protection w/ Auto Recovery
- Recessed Steel Screws
- Surge Protector
- Vandal Resistant

## LINE DRAWING

LINE DRAWING NOT TO SCALE

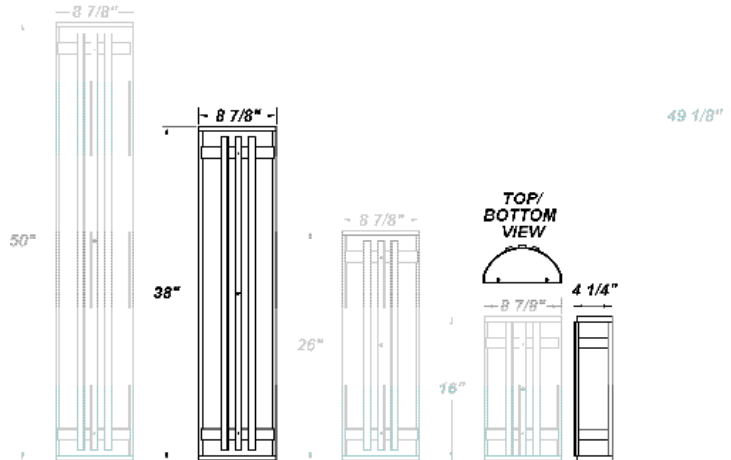

## FINISHES

Antique Copper



Antique Silver

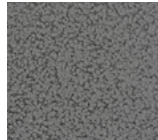

Bronze Mist

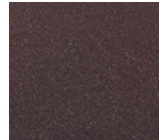

Matte Silver

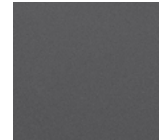

Sand

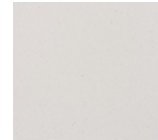

Swedish Steel

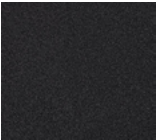

Textured Black



Textured Bronze

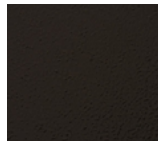

Textured White

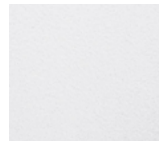

For RAL Colors & Custom Match - Contact Teron Lighting Inc.

# GUARDIAN W TXT LED 38"

Architectural Outdoor



Fixture Core

PROJECT:	
TYPE:	
PO#:	QTY:
COMMENTS:	

PRODUCT CODE	SOURCE/WATTAGE	VOLTAGE	DIMMING DRIVER
<b>GRDW36</b> - Guardian W 38"	<b>L36.5-ZE1050</b> - 36.5W @ Line Voltage 4-Wire Dimming Driver (Dimmable 0 - 10V) <b>L72.0-ZE714</b> - (700mA and 1400mA) 72.0W @ Line Voltage 4-Wire Dimming Driver (Dimmable 0 - 10V)	<b>120 - 277V</b> <b>347V Available For L36.5 Only</b>	<b>Not Applicable</b>
ORDER INFO			
GRDW36	L36.5-ZE1050	120 - 277V	Not Applicable

Example ^ (may not represent a manufacturable product)

Aesthetics & Options

TRIM	FINISH	COLOR TEMP	OPTIONS
<b>TXT</b>	<b>AC</b> - Antique Copper <b>TB</b> - Textured Black <b>AS</b> - Antique Silver <b>BT</b> - Bronze Mist <b>BZ</b> - Textured Bronze <b>SM</b> - Matte Silver (Standard) <b>TW</b> - Textured White <b>SN</b> - Sand <b>SW</b> - Swedish Steel	<b>30K</b> - 3000K Color Temp <b>35K</b> - 3500K Color Temp <b>40K</b> - 4000K Color Temp <b>50K</b> - 5000K Color Temp	<b>OEL</b> - Single End Window <b>TEL</b> - Twin End Windows (Both Ends) <b>EB10</b> - Iota ILB-CP10-B Integral 10W LED Driver <b>MSI</b> - Steinel HFLUM2-WR Internal Motion Sensor
ORDER INFO			
TXT	AC	30K	OEL

Example ^ (may not represent a manufacturable product)

PROD	SOURCE	30K SPECS			
<b>GRDW36</b>	L36.5	<ul style="list-style-type: none"> <li>80 CRI Typ.</li> <li>30K - 3000K Color Temp</li> <li>5993 LED Source Lumens</li> <li>156 LED Source Lumens Per Watt</li> </ul>			
	L72.0	<ul style="list-style-type: none"> <li>80 CRI Typ.</li> <li>30K - 3000K Color Temp</li> <li>10437 LED Source Lumens</li> <li>145 LED Source Lumens Per Watt</li> </ul>			

REPLACEMENT PART	PART NO	NOTES
3' Acrylic LED Lens Assembly	38217	

Don't see the configuration you are looking for?  
Call us today at (513) 858-6004



**TERONLIGHTING.COM**  
 33 DONALD DR, FAIRFIELD, OH 45014  
 P: 513.858.6004    F: 513.858.6038  
 E: SALES@TERONLIGHT.COM



We reserve the right to revise the design components of any product due to parts availability or change in UL standards, without assuming any obligation or liability to modify any products previously manufactured, and without notice.