

GUARDIAN W CNL LED 16"

Architectural Outdoor



PROJECT:	
TYPE:	
PO#:	QTY:
COMMENTS:	

FEATURES

- 120V - 277V, Plus 347V For Selected Wattages
- Aluminum Fascia w/ Matte Silver Polyester Powder Coat Finish
- Aluminum Reflector w/ Hi-Reflectance White Powder Coat Finish
- CSA Listed Wet Location Vertical Position Only
- CSA Listed Damp Location Horizontal Position
- Die Cast Aluminum End Caps w/ Matte Silver Polyester Powder Coat Finish
- Extruded Aluminum Housing w/ Matte Silver Polyester Powder Coat Finish
- Fixture Mounts Directly to Surface w/ Two Wall Anchors (Not Included)
- High Impact White Acrylic Diffuser (50% DR Acrylic)
- LED Light Fixture
- Over-Voltage, Over-Current, and Short-Circuit Protection w/ Auto Recovery
- Recessed Steel Screws
- Surge Protector
- Vandal Resistant

LINE DRAWING

LINE DRAWING NOT TO SCALE

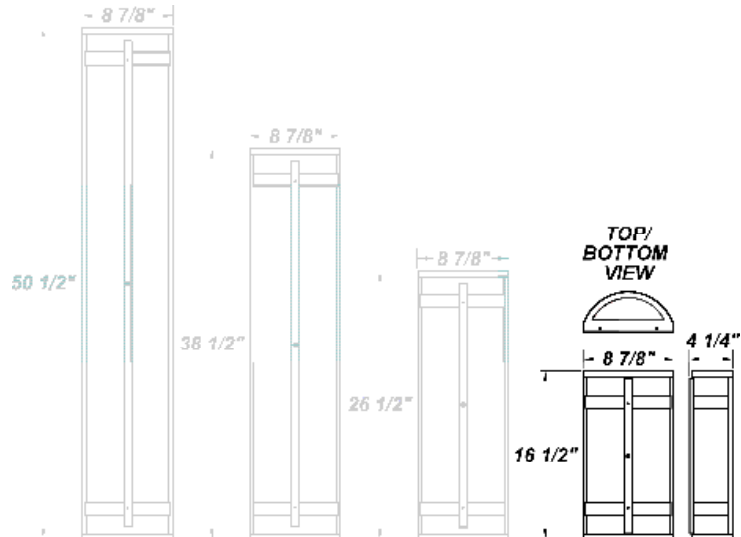

FINISHES

Antique Copper

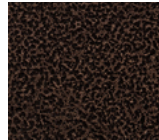

Antique Silver

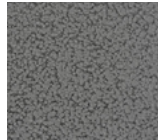

Bronze Mist

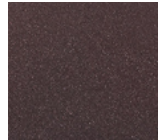

Matte Silver

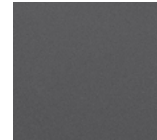

Sand

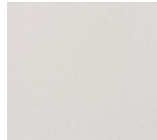

Swedish Steel

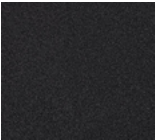

Textured Black

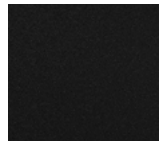

Textured Bronze

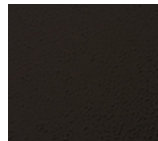

Textured White

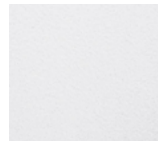

For RAL Colors & Custom Match - Contact Teron Lighting Inc.



GUARDIAN W CNL LED 16"

Architectural Outdoor



Fixture Core

PROJECT:	
TYPE:	
PO#:	QTY:
COMMENTS:	

PRODUCT CODE	SOURCE/WATTAGE	VOLTAGE	DIMMING DRIVER
GRDW16 - Guardian W 16"	L12.0-TE350 - 12W @ 350mA ELV Dimming Driver L12.0-ZE350 - 12W @ Line Voltage 4-Wire Dimming Driver (Dimmable 0 - 10V) L18.0-TE500 - 18W @ 500mA ELV Dimming Driver	120 - 277V	Not Applicable
ORDER INFO			
GRDW16	L12.0-TE350	120 - 277V	Not Applicable

Example ^ (may not represent a manufacturable product)

Aesthetics & Options

TRIM	FINISH	COLOR TEMP	OPTIONS
CNL	AC - Antique Copper TB - Textured Black AS - Antique Silver BT - Bronze Mist BZ - Textured Bronze SM - Matte Silver (Standard) TW - Textured White SN - Sand SW - Swedish Steel	30K - 3000K Color Temp 35K - 3500K Color Temp 40K - 4000K Color Temp 50K - 5000K Color Temp	OEL - Single End Window TEL - Twin End Windows (Both Ends)
ORDER INFO			
CNL	AC	30K	OEL

Example ^ (may not represent a manufacturable product)

PROD	SOURCE	30K SPECS			
GRDW	L12.0	<ul style="list-style-type: none"> 80 CRI Typ. 30K - 3000K Color Temp 1739 LED Source Lumens 144.9 LED Source Lumens Per Watt 			
	L18.0	<ul style="list-style-type: none"> 80 CRI Typ. 30K - 3000K Color Temp 2711 LED Source Lumens 150.6 LED Source Lumens Per Watt 			

REPLACEMENT PART	PART NO	NOTES
16" Acrylic LED Lens Assembly	38200	(L18.0 is Dimmable From 120 - 230V)

Don't see the configuration you are looking for?
Call us today at (513) 858-6004



TERONLIGHTING.COM
33 DONALD DR, FAIRFIELD, OH 45014
P: 513.858.6004 F: 513.858.6038
E: SALES@TERONLIGHT.COM



We reserve the right to revise the design components of any product due to parts availability or change in UL standards, without assuming any obligation or liability to modify any products previously manufactured, and without notice.

GUARDIAN W CNL LED 16"

Architectural Outdoor



Fixture Core

PROJECT:	
TYPE:	
PO#:	QTY:
COMMENTS:	

PRODUCT CODE	SOURCE/WATTAGE	VOLTAGE	DIMMING DRIVER
GRDW16 - Guardian W 16"	L18.0-LE500 - 18W @ 500mA 2-Wire Dimming Driver (120V Only) L18.0-ZE500 - 18W @ Line Voltage 4-Wire Dimming Driver (Dimmable 0 - 10V) L24.5-12CV - 12V Constant Voltage Non-Dimming Electronic Driver	120 - 277V	Not Applicable
ORDER INFO			
GRDW16	L18.0-LE500	120 - 277V	Not Applicable

Example ^ (may not represent a manufacturable product)

Aesthetics & Options

TRIM	FINISH	COLOR TEMP	OPTIONS
CNL	AC - Antique Copper TB - Textured Black AS - Antique Silver BT - Bronze Mist BZ - Textured Bronze SM - Matte Silver (Standard) TW - Textured White SN - Sand SW - Swedish Steel	30K - 3000K Color Temp 35K - 3500K Color Temp 40K - 4000K Color Temp 50K - 5000K Color Temp	OEL - Single End Window TEL - Twin End Windows (Both Ends)
ORDER INFO			
CNL	AC	30K	OEL

Example ^ (may not represent a manufacturable product)

PROD	SOURCE	30K SPECS			
GRDW	L18.0	<ul style="list-style-type: none"> 80 CRI Typ. 30K - 3000K Color Temp 2711 LED Source Lumens 150.6 LED Source Lumens Per Watt 			
	L24.5	<ul style="list-style-type: none"> 80 CRI Typ. 30K - 3000K Color Temp 9 LEDs Per ThermAdjust Module 2528 LED Source Lumens 103.2 LED Source Lumens Per Watt 			

REPLACEMENT PART	PART NO	NOTES
16" Acrylic LED Lens Assembly	38200	(L18.0 is Dimmable From 120 - 230V)

Don't see the configuration you are looking for?
Call us today at (513) 858-6004



TERONLIGHTING.COM
 33 DONALD DR, FAIRFIELD, OH 45014
 P: 513.858.6004 F: 513.858.6038
 E: SALES@TERONLIGHT.COM



We reserve the right to revise the design components of any product due to parts availability or change in UL standards, without assuming any obligation or liability to modify any products previously manufactured, and without notice.