

KATONA BFP LED 36" MCT

Architectural Indoor



PROJECT:	
TYPE:	
PO#:	QTY:
COMMENTS:	

FEATURES

- Acrylic Lens
- Anodized Aluminum Reflector
- Die-Formed Cold-Rolled Steel Housing
- Energy Star
- ETL/cETL Listed Dry Location
- LED Light Fixture
- MCT (Multi Color Tuning) 3000K, 3500K, 4000K
- Mounts Directly to 4" Junction Box (By Others)
- Mounting Hardware Included
- UL/cUL Listed



LINE DRAWING

LINE DRAWING NOT TO SCALE

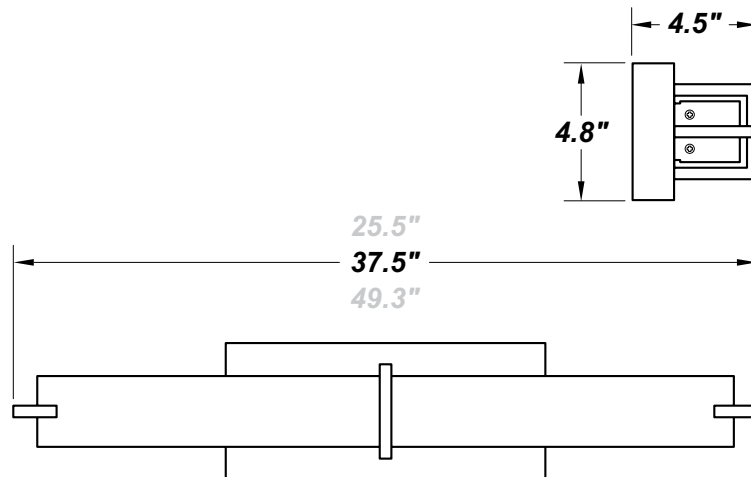

FINISHES

Brushed
Nickel

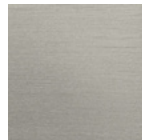

KATONA BFP LED 36" MCT

Architectural Indoor



Fixture Core

PROJECT:	
TYPE:	
PO#:	QTY:
COMMENTS:	

PRODUCT CODE	SOURCE/WATTAGE	VOLTAGE	DIMMING DRIVER
KA36 - Katona 36"	L23.0-700 - (1) 23W @ 700mA	UNV - 120V-277V (50/60 Hz)	Not Applicable
ORDER INFO			
KA36 Example ^	L23.0-700	UNV	Not Applicable

Aesthetics & Options

TRIM	FINISH	COLOR TEMP	OPTIONS
Not Applicable	BN - Brushed Nickel (Standard)	MCT - 3000K, 3500K, 4000K Color Temps.	Not Applicable
ORDER INFO			
Not Applicable Example ^	BN	MCT	Not Applicable

PROD	SOURCE	30K SPECS			
KA36	L23.0	<ul style="list-style-type: none"> 30K - 3000K Color Temp 2128.4 LED Delivered Lumens 91 LED Delivered Lumens Per Watt 			

REPLACEMENT PART	PART NO	NOTES
		KA36 L70 >50,000 hrs Minimum Starting Temperature = -20 Degrees C



TERONLIGHTING.COM
 33 DONALD DR, FAIRFIELD, OH 45014
 P: 513.858.6004 F: 513.858.6038
 E: SALES@TERONLIGHT.COM

We reserve the right to revise the design components of any product due to parts availability or change in UL standards, without assuming any obligation or liability to modify any products previously manufactured, and without notice.