

VICEROY W DL LED 36"

Architectural Outdoor

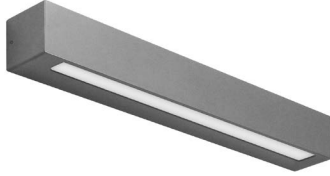

PROJECT:	
TYPE:	
PO#:	QTY:
COMMENTS:	



FEATURES

- ADA Compliant
- Aluminum Fixture w/ Matte Silver Powder Coat Finish
- Aluminum Mounting Plate Mounts to Wall Surface (Centered Over Conduit)
- CSA Listed Wet Location For Wall Mount
- Dimmable @ 120-277V
- Estimated Lumen Depreciation (TM-21) 70% of Initial Lumens (L70) @ 90,000 Hours
- Integral Surge Protector
- Leading or Trailing edge or 0-10V Dimming Available
- LED Light Fixture
- Requires a 1/2" Watertight Conduit Connector (Not Included)
- White Acrylic Lens
- 0-10V Dimming

LINE DRAWING

LINE DRAWING NOT TO SCALE

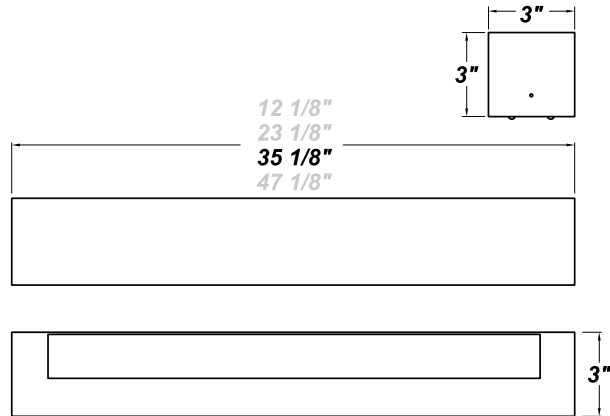

FINISHES

Antique Copper



Antique Silver



Bronze Mist



Matte Silver

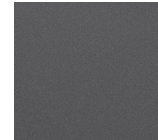

Sand

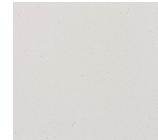

Swedish Steel

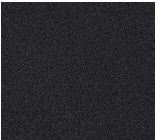

Textured Black

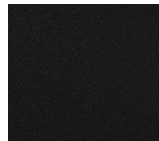

Textured Bronze

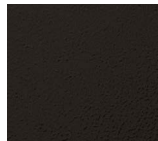

Textured White

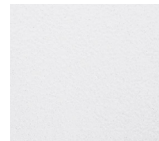

For RAL Colors & Custom Match - Contact Teron Lighting Inc.

VICEROY W DL LED 36"

Architectural Outdoor



Fixture Core

PROJECT:	
TYPE:	
PO#:	QTY:
COMMENTS:	

PRODUCT CODE	SOURCE/WATTAGE	VOLTAGE	DIMMING DRIVER
VCYV36 - Viceroy W 36"	L28.0-ZE880 - 30.0W LED Strip(s) @ 880mA Line Voltage 4-Wire Dimming Driver (Dimmable 0 - 10V)	120-277V	0-10V Dimming
ORDER INFO			
VCYW36 Example ^	L28.0-ZE880	120-277V	Not Applicable

Aesthetics & Options

TRIM	FINISH	COLOR TEMP	OPTIONS
DL	AC - Antique Copper AS - Antique Silver BT - Bronze Mist BZ - Textured Bronze SM - Matte Silver (Standard) SN - Sand SW - Swedish Steel TB - Textured Black TW - Textured White	30K - 3000K Color Temp 35K - 3500K Color Temp 40K - 4000K Color Temp 50K - 5000K Color Temp	Not Applicable
ORDER INFO			
DL Example ^	SM	30K	Not Applicable

PROD	SOURCE	30K SPECS			
VCYW36	L28.0	<ul style="list-style-type: none"> 30K - 3000K Color Temp 1349 LED Delivered Lumens 48 LED Delivered Lumens Per Watt 			

REPLACEMENT PART	PART NO	NOTES
3' Lens Assembly	3060160	

Don't see the configuration you are looking for?
Call us today at (513) 858-6004



TERONLIGHTING.COM
 33 DONALD DR, FAIRFIELD, OH 45014
 P: 513.858.6004 F: 513.858.6038
 E: SALES@TERONLIGHT.COM



We reserve the right to revise the design components of any product due to parts availability or change in UL standards, without assuming any obligation or liability to modify any products previously manufactured, and without notice.