

VICEROY LED 24"

Architectural Indoor



PROJECT:	
TYPE:	
PO#:	QTY:
COMMENTS:	

FEATURES

- ADA Compliant
- Clear Acrylic Outer Diffuser
- Constant Current
- CSA Listed Damp Location For Wall or Ceiling Mount
- Dimmable to 10% From 120V to 277V
- ELV Driver - Over-Voltage, Over-Current, and Short-Circuit Protection with Auto Recovery
- IES Files Available
- LED Light Fixture
- Lighting Facts Listed
- L70 Life Time For 50,000hr
- Matte White Acrylic Inner Diffuser
- Mounts Directly to Surface with Two Wall Anchors (Not Included) Over a 2" Junction Box (Not Included)
- Prepainted White Steel Mount Pan
- Steel Housing with Matte Silver Powder Coat Finish

LINE DRAWING

LINE DRAWING NOT TO SCALE

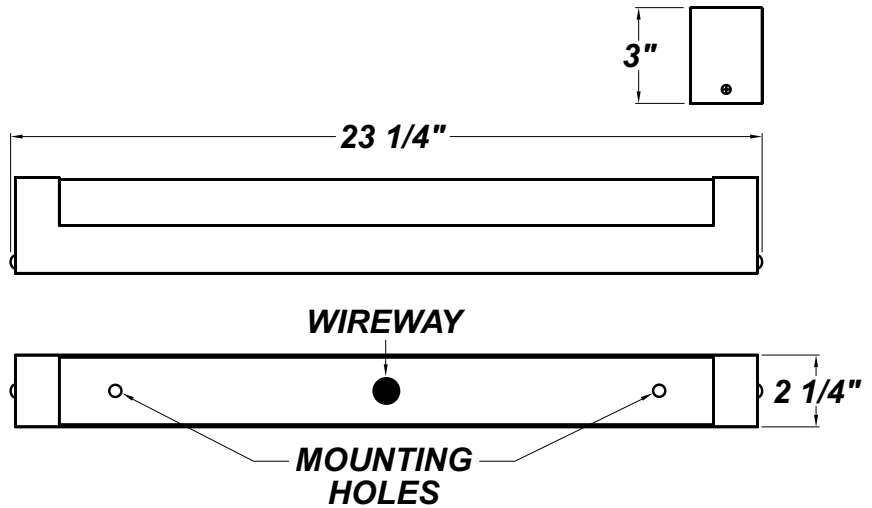

FINISHES

Antique Copper



Antique Silver

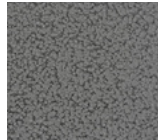

Bronze Mist

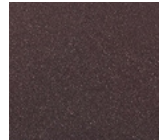

Matte Silver

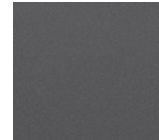

Sand

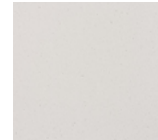

Swedish Steel

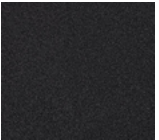

Textured Black

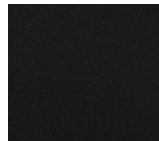

Textured Bronze

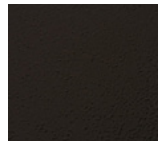

Textured White

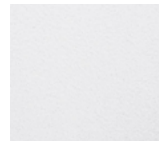

For RAL Colors & Custom Match - Contact Teron Lighting Inc.

VICEROY LED 24"

Architectural Indoor



Fixture Core

PROJECT:	
TYPE:	
PO#:	QTY:
COMMENTS:	

PRODUCT CODE	SOURCE/WATTAGE	VOLTAGE	DIMMING DRIVER
VCY24 - Viceroy 24"	L12.0-LT350 - 12W LED Strip(s) @ 350mA ELV Dimming Driver L18.0-LT500 - 18.0W LED Strip(s) @ 500mA ELV Dimming Driver L18.0-ZE500 - 18.0W LED Strip(s) @ 500mA Line Voltage 4-Wire Dimming Driver (Dimmable 0 - 10V)	120-277V (120-230V Dimmable)	Not Applicable
ORDER INFO			
VCY24 Example ^	L12.0-LT350	120-277V	Not Applicable

Aesthetics & Options

TRIM	FINISH	COLOR TEMP	OPTIONS
Not Applicable	AC - Antique Copper AS - Antique Silver BT - Bronze Mist BZ - Textured Bronze SM - Matte Silver (Standard) SN - Sand SW - Swedish Steel TB - Textured Black TW - Textured White	30K - 3000K Color Temp 35K - 3500K Color Temp 40K - 4000K Color Temp	F - Single Fuse 120-277V JBC - 4" x 4" Junction Box Cover (Mounts to Fixture, Allowing it to be Retro-fitted Over an Existing Junction Box) TP - Tamper-Proof Screw Set
ORDER INFO			
Not Applicable Example ^	AC	30K	F

PROD	SOURCE	30K SPECS				
VCY24	L12.0	<ul style="list-style-type: none"> 30K - 3000K Color Temp 1400 LED Source Lumens 116.7 LED Source Lumens Per Watt 				
	L18.0	<ul style="list-style-type: none"> 30K - 3000K Color Temp 1986 LED Source Lumens 110.3 LED Source Lumens Per Watt 				

REPLACEMENT PART	PART NO	NOTES
2' Lens Assembly	38090	

Don't see the configuration you are looking for?
Call us today at (513) 858-6004



TERONLIGHTING.COM
 33 DONALD DR, FAIRFIELD, OH 45014
 P: 513.858.6004 F: 513.858.6038
 E: SALES@TERONLIGHT.COM



We reserve the right to revise the design components of any product due to parts availability or change in UL standards, without assuming any obligation or liability to modify any products previously manufactured, and without notice.

VICEROY LED 24"

Architectural Indoor



Fixture Core

PROJECT:	
TYPE:	
PO#:	QTY:
COMMENTS:	

PRODUCT CODE	SOURCE/WATTAGE	VOLTAGE	DIMMING DRIVER
VCY24 - Viceroy 24"	L20.6-ZE600 - 20.6W LED Strip(s) @ 600mA Line Voltage 4-Wire Dimming Driver (Dimmable 0 - 10V)	120-277V (120-230V Dimmable)	Not Applicable
ORDER INFO			
VCY24 Example ^	L20.6-ZE600	120-277V	Not Applicable

Aesthetics & Options

TRIM	FINISH	COLOR TEMP	OPTIONS
Not Applicable	AC - Antique Copper AS - Antique Silver BT - Bronze Mist BZ - Textured Bronze SM - Matte Silver (Standard) SN - Sand SW - Swedish Steel TB - Textured Black TW - Textured White	30K - 3000K Color Temp 35K - 3500K Color Temp 40K - 4000K Color Temp	F - Single Fuse 120-277V JBC - 4" x 4" Junction Box Cover (Mounts to Fixture, Allowing it to be Retro-fitted Over an Existing Junction Box) TP - Tamper-Proof Screw Set
ORDER INFO			
Not Applicable Example ^	AC	30K	F

PROD	SOURCE	30K SPECS			
VCY24	L20.6	<ul style="list-style-type: none"> 30K - 3000K Color Temp 1839 LED Delivered Lumens 99.5 Delivered Lumens Per Watt 			

REPLACEMENT PART	PART NO	NOTES
2' Lens Assembly	38090	

Don't see the configuration you are looking for?
Call us today at (513) 858-6004



TERONLIGHTING.COM
 33 DONALD DR, FAIRFIELD, OH 45014
 P: 513.858.6004 F: 513.858.6038
 E: SALES@TERONLIGHT.COM



We reserve the right to revise the design components of any product due to parts availability or change in UL standards, without assuming any obligation or liability to modify any products previously manufactured, and without notice.