

CADDY SQUARE LED

Architectural Outdoor



PROJECT:	
TYPE:	
PO#:	QTY:
COMMENTS:	



FEATURES

- Aluminum Heat-Sink Plate
- Clear Tempered Glass Lens
- CSA Approved Wet Location For Wall Mounting (Down Light Only)
- Dark Sky Compliant
- Die-Cast Aluminum Housing w/ Textured Bronze Polyester Powder Coat Finish
- Emergency Battery Available
- Fully Gasketed
- LED Light Fixture
- Mounts Directly to 4" Junction Box
- Optional Semi-Opaque Polycarbonate Diffuser
- Surge Protector
- 120V - 277V



LINE DRAWING

LINE DRAWING NOT TO SCALE

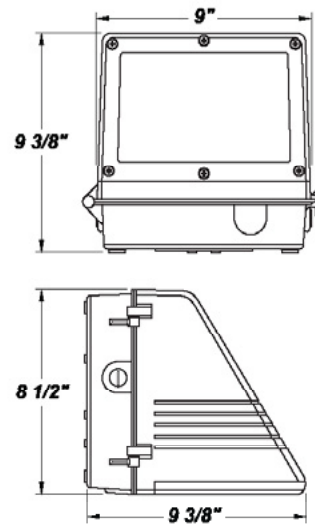

FINISHES

Antique Copper



Antique Silver

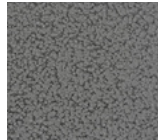

Bronze Mist

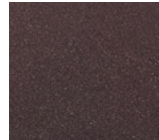

Matte Silver

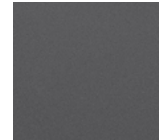

Sand

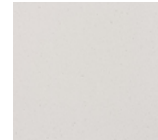

Swedish Steel

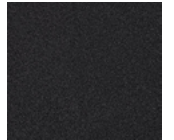

Textured Black



Textured Bronze

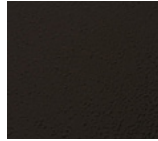

Textured White



For RAL Colors & Custom Match - Contact Teron Lighting Inc.



CADDY SQUARE LED

Architectural Outdoor



Fixture Core

PROJECT:	
TYPE:	
PO#:	QTY:
COMMENTS:	

PRODUCT CODE	SOURCE/WATTAGE	VOLTAGE	DIMMING DRIVER
CDSQ - Caddy Square	L12.0-LT300 - 12.0W @ 300mA ELV Dimming Driver L14.0-LT350 - 14.0W @ 350mA ELV Dimming Driver L20.0-LT500 - 20.0W @ 500mA ELV Dimming Driver L26.0-ZE600 - 26.0W @ 600mA 0-10V Dimming Driver	120 - 277V	Not Applicable
ORDER INFO			
CDSQ	L12.0-LT300	120 - 277V	Not Applicable

Example ^ (may not represent a manufacturable product)

Aesthetics & Options

TRIM	FINISH	COLOR TEMP	OPTIONS
Not Applicable	AC - Antique Copper AS - Antique Silver BT - Bronze Mist SM - Matte Silver SN - Sand SW - Swedish Steel TB - Textured Black	BZ - Textured Bronze (Standard) TW - Textured White 30K - 3000K Color Temp 35K - 3500K Color Temp 40K - 4000K Color Temp 50K - 5000K Color Temp	EB5 - 5 Watt Integral Battery EBCA4 - Title 20 Compliant 4 Watt Integral Battery F - Fused MIV - 20 Watt Micro-Inverter (Remote) PCL* - Photocell SPL - Semi Frosted Polycarb Lens TP - Tamper Resistant Screws
ORDER INFO			
Not Applicable	AC	30K	EB5

Example ^ (may not represent a manufacturable product)

PROD	SOURCE	30K SPECS	30K SPECS (SPL)			
CDSQ	L12.0	<ul style="list-style-type: none"> 30K - 3000K Color Temp 1384.3 LED Source Lumens 115.3 LED Source Lumens Per Watt 	<ul style="list-style-type: none"> 30K - 3000K Color Temp 1384.3 LED Source Lumens 115.3 LED Source Lumens Per Watt 			
	L14.0	<ul style="list-style-type: none"> 30K - 3000K Color Temp 1615 LED Source Lumens 115.3 LED Source Lumens Per Watt 	<ul style="list-style-type: none"> 30K - 3000K Color Temp 1615 LED Source Lumens 115.3 LED Source Lumens Per Watt 			
	L20.0	<ul style="list-style-type: none"> 30K - 3000K Color Temp 2307.1 LED Source Lumens 115.3 LED Source Lumens Per Watt 	<ul style="list-style-type: none"> 30K - 3000K Color Temp 2307.1 LED Source Lumens 115.3 LED Source Lumens Per Watt 			
	L26.0	<ul style="list-style-type: none"> 30K - 3000K Color Temp 2212 LED Delivered Lumens 85 LED Delivered Lumens Per Watt 	<ul style="list-style-type: none"> 30K - 3000K Color Temp 1798 LED Delivered Lumens 69.1 LED Delivered Lumens Per Watt 			

REPLACEMENT PART	PART NO	NOTES
Semi Frosted Polycarb Lens	3411762	* Photocell Can Not Be Ordered With EB Option. Don't see the configuration you are looking for? Call us today at (513) 858-6004



TERONLIGHTING.COM
 33 DONALD DR, FAIRFIELD, OH 45014
 P: 513.858.6004 F: 513.858.6038
 E: SALES@TERONLIGHT.COM



We reserve the right to revise the design components of any product due to parts availability or change in UL standards, without assuming any obligation or liability to modify any products previously manufactured, and without notice.