

NIKE BFP LED 24"

Architectural Indoor



PROJECT:	
TYPE:	
PO#:	QTY:
COMMENTS:	

FEATURES

- Anodized Aluminum Reflector
- Die-Formed Cold-Rolled Steel Housing
- Energy Star
- ETL/cETL Listed Dry Location
- LED Light Fixture
- Mounts Directly to 4" Junction Box (By Others)
- Mounting Hardware Included
- White Acrylic Lens



LINE DRAWING

LINE DRAWING NOT TO SCALE

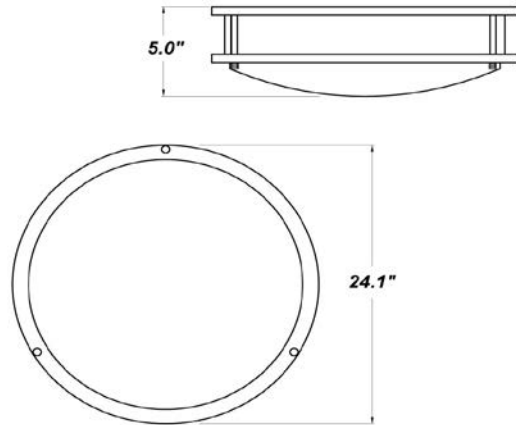

FINISHES

Brushed
Nickel



NIKE BFP LED 24"

Architectural Indoor



Fixture Core

PROJECT:	
TYPE:	
PO#:	QTY:
COMMENTS:	

PRODUCT CODE	SOURCE/WATTAGE	VOLTAGE	DIMMING DRIVER
NEB24 - Nike BFP LED 24"	L40.0-1750 - (1) 40W @ 1750mA	120V - 277V	Not Applicable
ORDER INFO			
NEB24	L35.0-1050	120/277V	Not Applicable

Example ^

Aesthetics & Options

TRIM	FINISH	COLOR TEMP	OPTIONS
Not Applicable	BN - Brushed Nickel (Standard)	30K - 3000K Color Temp. 40K - 4000K Color Temp.	FM - Flush Mount PM - Pendant Mout (6" Stem)
ORDER INFO			
Not Applicable	BN	30K	FM

Example ^

PROD	SOURCE	30K SPECS			
NEB24	L40	<ul style="list-style-type: none"> 30K - 3000K Color Temp 3745.7 LED Delivered Lumens 93.6 LED Source Lumens Per Watt 80 CRI 			

REPLACEMENT PART	PART NO	NOTES



TERONLIGHTING.COM
 33 DONALD DR, FAIRFIELD, OH 45014
 P: 513.858.6004 F: 513.858.6038
 E: SALES@TERONLIGHT.COM

We reserve the right to revise the design components of any product due to parts availability or change in UL standards, without assuming any obligation or liability to modify any products previously manufactured, and without notice.