

NIKE PD BFP LED 16"

Architectural Indoor



PROJECT:	
TYPE:	
PO#:	QTY:
COMMENTS:	

FEATURES

- Die-Formed Cold-Rolled Steel Housing
- Anodized Aluminum Reflector
- White Acrylic Lens
- Mounts Directly to 4" Junction Box (By Others)
- ETL/cETL Listed Dry Location
- LED Light Fixture
- Mounting Hardware Included



LINE DRAWING

LINE DRAWING NOT TO SCALE

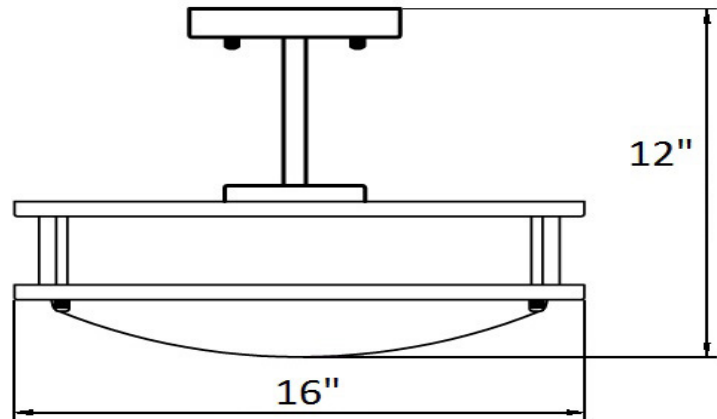

FINISHES

Brushed
Nickel



NIKE PD BFP LED 16"

Architectural Indoor



Fixture Core

PROJECT:	
TYPE:	
PO#:	QTY:
COMMENTS:	

PRODUCT CODE	SOURCE/WATTAGE	VOLTAGE	DIMMING DRIVER
NEBPD16 - Nike PD BFP LED 16"	L28.0-840 - (1) 30W @ 840mA	120V - 277V	Not Applicable
ORDER INFO			
NEBPD16	L28.0-840	120/277V	Not Applicable

Example ^

Aesthetics & Options

TRIM	FINISH	COLOR TEMP	OPTIONS
Not Applicable	BN - Brushed Nickel (Standard)	30K - 3000K Color Temp. 40K - 4000K Color Temp.	Not Applicable
ORDER INFO			
Not Applicable	BN	30K	Not Applicable

Example ^

PROD	SOURCE	30K SPECS				
NEBPD16	L30	<ul style="list-style-type: none"> 30K - 3000K Color Temp 3364.2 LED Delivered Lumens 90.9 LED Source Lumens Per Watt 80 CRI 				

REPLACEMENT PART	PART NO	NOTES



TERONLIGHTING.COM
 33 DONALD DR, FAIRFIELD, OH 45014
 P: 513.858.6004 F: 513.858.6038
 E: SALES@TERONLIGHT.COM

We reserve the right to revise the design components of any product due to parts availability or change in UL standards, without assuming any obligation or liability to modify any products previously manufactured, and without notice.