

NIKE BFP LED 12"

Architectural Indoor



PROJECT:	
TYPE:	
PO#:	QTY:
COMMENTS:	

FEATURES

- Anodized Aluminum Reflector
- Die-Formed Cold-Rolled Steel Housing
- Energy Star
- ETL/cETL Listed Dry Location
- LED Light Fixture
- Mounts Directly to 4" Junction Box (By Others)
- Mounting Hardware Included
- White Acrylic Lens



LINE DRAWING

LINE DRAWING NOT TO SCALE

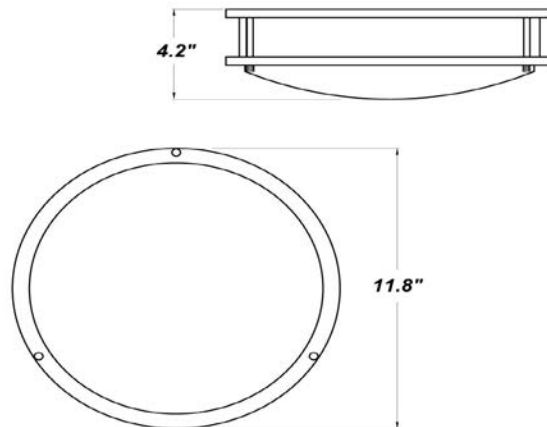

FINISHES

Brushed
Nickel



NIKE BFP LED 12"

Architectural Indoor



Fixture Core

PROJECT:	
TYPE:	
PO#:	QTY:
COMMENTS:	

PRODUCT CODE	SOURCE/WATTAGE	VOLTAGE	DIMMING DRIVER
NEB12 - Nike BFP LED 12"	L18.0-LT500 - (1) 18W @ 500mA Triac Dimming Driver	120V (50/60 Hz)	Triac Dimming (120V Only)
ORDER INFO			
NEB12	L18.0-LT500	120V	Triac Dimming

Example ^

Aesthetics & Options

TRIM	FINISH	COLOR TEMP	OPTIONS
Not Applicable	BN - Brushed Nickel (Standard)	30K - 3000K Color Temp. 40K - 4000K Color Temp.	FM - Flush Mount PM - Pendant Mout (6" Stem)
ORDER INFO			
Not Applicable	BN	30K	FM

Example ^

PROD	SOURCE	30K SPECS			
NEB12	L18.0	<ul style="list-style-type: none"> 30K - 3000K Color Temp 1423.9 LED Delivered Lumens 79.1 LED Source Lumens Per Watt 80 CRI 			

REPLACEMENT PART	PART NO	NOTES



TERONLIGHTING.COM
 33 DONALD DR, FAIRFIELD, OH 45014
 P: 513.858.6004 F: 513.858.6038
 E: SALES@TERONLIGHT.COM

We reserve the right to revise the design components of any product due to parts availability or change in UL standards, without assuming any obligation or liability to modify any products previously manufactured, and without notice.