

CAPRI BFP LED 48"

Architectural Indoor



PROJECT:	
TYPE:	
PO#:	QTY:
COMMENTS:	

FEATURES

- ADA Compliant
- CSA Listed Damp Location For Wall or Ceiling Mounting
- L30.9 and L40.6 are Dimmable at 120V and 277V
- LED Light Fixture
- Luminous White Acrylic Diffuser
- Mounts Directly to Surface w/ Four Wall Anchors (Not Included)
- Steel Housing w/ Matte Silver Powder Coat Finish
- Steel Mounting Pan w/ Hi-Reflectance White Powder Coat Finish

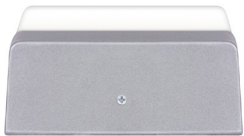
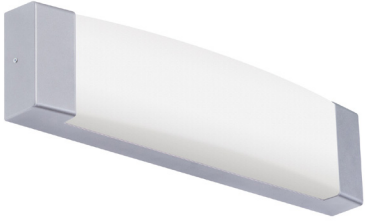

LINE DRAWING

LINE DRAWING NOT TO SCALE

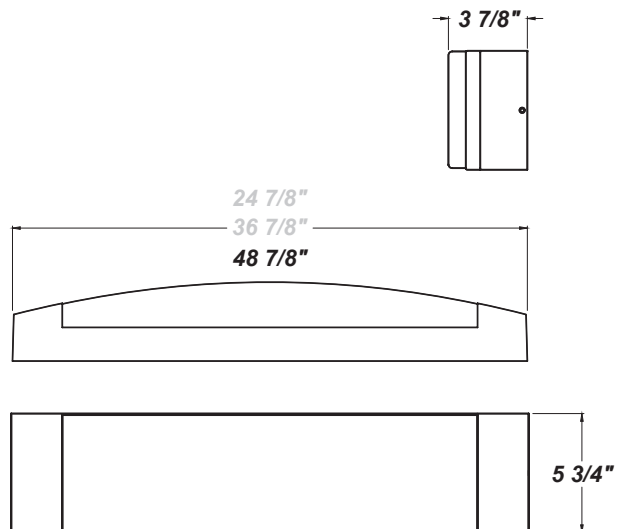

FINISHES

Antique Copper



Antique Silver

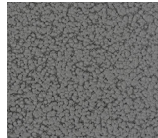

Bronze Mist

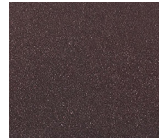

Matte Silver

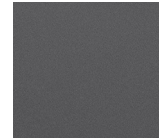

Sand

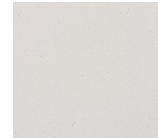

Swedish Steel

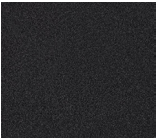

Textured Black

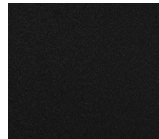

Textured Bronze

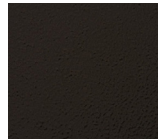

Textured White

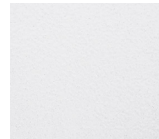

For RAL Colors & Custom Match - Contact Teron Lighting Inc.

CAPRI BFP LED 48"

Architectural Indoor



Fixture Core

PROJECT:	
TYPE:	
PO#:	QTY:
COMMENTS:	

PRODUCT CODE	SOURCE/WATTAGE	VOLTAGE	DIMMING DRIVER
CPRB48 - Capri BFP LED 48"	L30.9-ZE1100 - 30.9W @ 1100mA 0-10V Dimming Driver L40.6-ZE1400 - 40.6W @ 1400mA 0-10V Dimming Driver	120V 277V	0-10V Dimming 0-10V Dimming
ORDER INFO			
CPRB48 Example ^	L30.9-ZE1100	120V	Not Applicable

Aesthetics & Options

TRIM	FINISH	COLOR TEMP	OPTIONS
Not Applicable	AC - Antique Copper AS - Antique Silver BT - Bronze Mist SM - Matte Silver (Standard) SN - Sand SW - Swedish Steel TB - Textured Black BZ - Textured Bronze TW - Textured White	30K - 3000K Color Temp 35K - 3500K Color Temp 40K - 4000K Color Temp 50K - 5000K Color Temp	TP - Tamper Resistant Screws
ORDER INFO			
Not Applicable Example ^	AC	30K	TP

PROD	SOURCE	30K SPECS			
CPRB 48"	L30.9	<ul style="list-style-type: none"> 30K - 3000K Color Temp 4376 LED Source Lumens 141.6 LED Source Lumens Per Watt 			
	L40.6	<ul style="list-style-type: none"> 30K - 3000K Color Temp 5570 LED Source Lumens 137.2 LED Source Lumens Per Watt 			

REPLACEMENT PART	PART NO	NOTES
White 4' Acrylic Diffuser	3040460	
		Don't see the configuration you are looking for? Call us today at (513) 858-6004



TERONLIGHTING.COM
33 DONALD DR, FAIRFIELD, OH 45014
P: 513.858.6004 F: 513.858.6038
E: SALES@TERONLIGHT.COM



We reserve the right to revise the design components of any product due to parts availability or change in UL standards, without assuming any obligation or liability to modify any products previously manufactured, and without notice.