

CAPRI BFP LED 24"

Architectural Indoor



PROJECT:	
TYPE:	
PO#:	QTY:
COMMENTS:	

FEATURES

- Steel Housing w/ Matte Silver Powder Coat Finish
- Steel Mounting Pan w/ Hi-Reflectance White Powder Coat Finish
- Luminous White Acrylic Diffuser
- Mounts Directly to Surface w/ Four Wall Anchors (Not Included)
- L31.6 is Dimmable at 120V and 277V
- ADA Compliant
- CSA Listed Damp Location For Wall or Ceiling Mounting
- LED Light Fixture

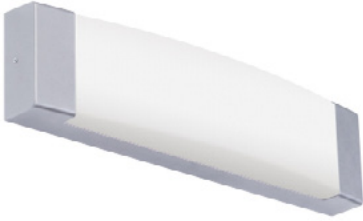

LINE DRAWING

LINE DRAWING NOT TO SCALE

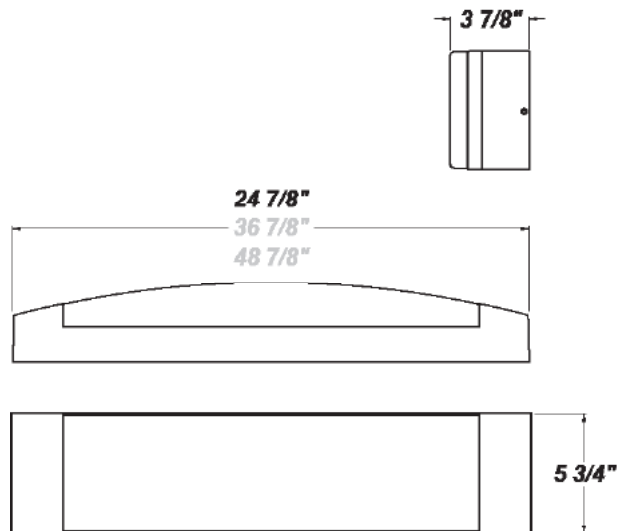

FINISHES

Antique Copper



Antique Silver

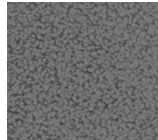

Bronze Mist

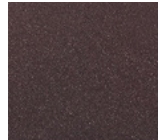

Matte Silver

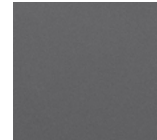

Metallic Black

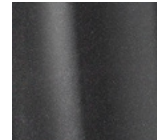

Sand

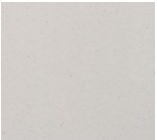

Swedish Steel

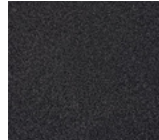

Textured Black

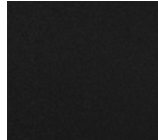

Textured Bronze

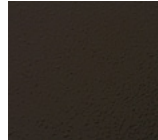

Textured White

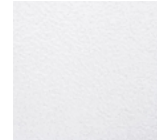

For RAL Colors & Custom Match - Contact Teron Lighting Inc.

CAPRI BFP LED 24"

Architectural Indoor



Fixture Core

PROJECT:	
TYPE:	
PO#:	QTY:
COMMENTS:	

PRODUCT CODE	SOURCE/WATTAGE	VOLTAGE	DIMMING DRIVER
CPRII24 - Capri II 24"	L31.6-ZE1100 - 31.6W @ 1100mA 0-10V Dimming Driver	120V 277V	0-10V Dimming
ORDER INFO			
CPRII24 Example ^	L31.6-ZE1100	120V	Not Applicable

Aesthetics & Options

TRIM	FINISH	COLOR TEMP	OPTIONS
Not Applicable	AC - Antique Copper AS - Antique Silver BT - Bronze Mist MB - Metallic Black SM - Matte Silver (Standard) SN - Sand SW - Swedish Steel TB - Textured Black BZ - Textured Bronze TW - Textured White	30K - 3000K Color Temp 35K - 3500K Color Temp 40K - 4000K Color Temp 50K - 5000K Color Temp	TP - Tamper Resistant Screws
ORDER INFO			
Not Applicable Example ^	AC	30K	TP

PROD	SOURCE	30K SPECS			
CPRII 24"	L31.6	<ul style="list-style-type: none"> 30K - 3000K Color Temp 4376 LED Source Lumens 138.5 LED Source Lumens Per Watt 			

REPLACEMENT PART	PART NO	NOTES
White 2' Acrylic Diffuser	3039860	
		Don't see the configuration you are looking for? Call us today at (513) 858-6004



TERONLIGHTING.COM
 33 DONALD DR, FAIRFIELD, OH 45014
 P: 513.858.6004 F: 513.858.6038
 E: SALES@TERONLIGHT.COM



We reserve the right to revise the design components of any product due to parts availability or change in UL standards, without assuming any obligation or liability to modify any products previously manufactured, and without notice.