

ASTRO PD BFP LED 17"

Architectural Indoor



PROJECT:	
TYPE:	
PO#:	QTY:
COMMENTS:	

FEATURES

- Steel Housing with White Finish
- White Acrylic Diffuser
- ETL/cETL Listed Damp Location
- Energy Star
- Mounts Directly to Surface w/ Two Wall Anchors
- LED Light Fixture



LINE DRAWING

LINE DRAWING NOT TO SCALE

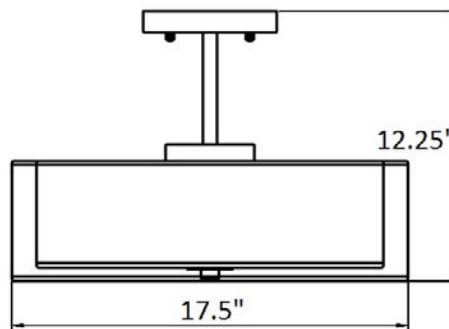

FINISHES

Brushed
Nickel



ASTRO PD BFP LED 17"

Architectural Indoor



Fixture Core

PROJECT:	
TYPE:	
PO#:	QTY:
COMMENTS:	

PRODUCT CODE	SOURCE/WATTAGE	VOLTAGE	DIMMING DRIVER
A017PD - Astro Pendant 17" (With 6" Stem)	L24.0-700 - (1) 24.0W @ 700mA	120V - 277V	Not Applicable
ORDER INFO			
AS17PD Example ^	L24.0-700	120/277V	Not Applicable

Aesthetics & Options

TRIM	FINISH	COLOR TEMP	OPTIONS
Not Applicable	BN - Brushed Nickel (Standard)	30K - 3000K Color Temp. 40K - 4000K Color Temp.	Not Applicable
ORDER INFO			
Not Applicable Example ^	BN	30K	Not Applicable

PROD	SOURCE	30K SPECS				
A017PD	L24.0	<ul style="list-style-type: none"> • 30K - 3000K Color Temp • 1788 LED Source Lumens • 100 LED Source Lumens Per Watt • 80 CRI 				

REPLACEMENT PART	PART NO	NOTES
		L70 >35,000 hrs Minimum Starting Temperature = -20 Degrees C



TERONLIGHTING.COM
 33 DONALD DR, FAIRFIELD, OH 45014
 P: 513.858.6004 F: 513.858.6038
 E: SALES@TERONLIGHT.COM

We reserve the right to revise the design components of any product due to parts availability or change in UL standards, without assuming any obligation or liability to modify any products previously manufactured, and without notice.