

ALANTE PD BFP LED 15"

Architectural Indoor



PROJECT:	
TYPE:	
PO#:	QTY:
COMMENTS:	

FEATURES

- Steel Housing w/ Brushed Nickel Powder Coat Finish
- White Acrylic Diffuser
- ETL/cETL Listed Dry Location
- Mounts Directly to Surface w/ Two Wall Anchors (Not Included)
- LED Light Fixture



LINE DRAWING

LINE DRAWING NOT TO SCALE

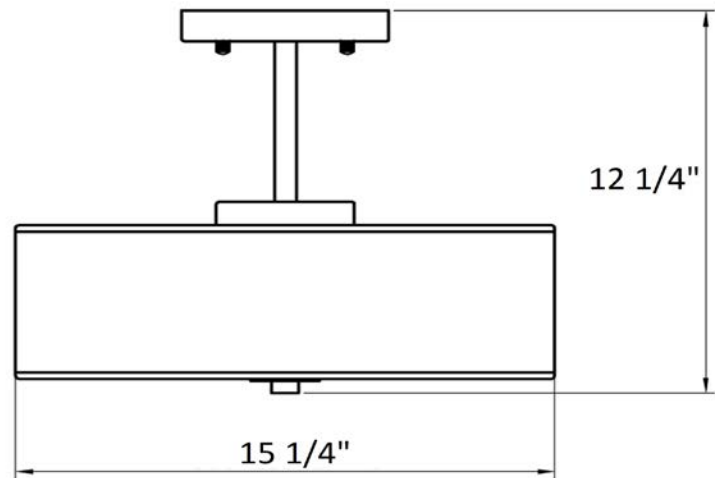

FINISHES

Brushed
Nickel



ALANTE PD BFP LED 15"

Architectural Indoor



Fixture Core

PROJECT:	
TYPE:	
PO#:	QTY:
COMMENTS:	

PRODUCT CODE	SOURCE/WATTAGE	VOLTAGE	DIMMING DRIVER
AE15PD - Alante Pendant 15" (With 6" Stem)	L24.0-700 - (1) 24W @ 700mA	120V - 277V	Not Applicable
ORDER INFO			
AE15 Example ^	L24.0-700	120/277V	Not Applicable

Aesthetics & Options

TRIM	FINISH	COLOR TEMP	OPTIONS
Not Applicable	BN - Brushed Nickel (Standard)	30K - 3000K Color Temp. 40K - 4000K Color Temp.	Not Applicable
ORDER INFO			
Not Applicable Example ^	BN	30K	Not Applicable

PROD	SOURCE	30K SPECS				
AE15PD	L24.0	<ul style="list-style-type: none"> 30K - 3000K Color Temp 1964 LED Source Lumens 108 LED Source Lumens Per Watt 80 CRI 				

REPLACEMENT PART	PART NO	NOTES
		L70 >35,000 hrs Minimum Starting Temperature = -20 Degrees C



TERONLIGHTING.COM
 33 DONALD DR, FAIRFIELD, OH 45014
 P: 513.858.6004 F: 513.858.6038
 E: SALES@TERONLIGHT.COM

We reserve the right to revise the design components of any product due to parts availability or change in UL standards, without assuming any obligation or liability to modify any products previously manufactured, and without notice.