

CAPRICCIO LED

Architectural Outdoor



PROJECT:	
TYPE:	
PO#:	QTY:
COMMENTS:	

FEATURES

- ADA Compliant
- Aluminum Fascia and Mount Pan w/ Matte Silver Powder Coat Finish
- CSA Listed Wet Location For Wall Mount Only
- Drivers are Constant Current Dimmable 0-10V
- Frosted White Acrylic Lens Assembly
- LED Light Fixture
- Mounts Directly to Flat Surface w/ Wall Anchors (By Others)
- Open Top and Bottom
- Self-Contained Waterproof LED Module Assembly
- UL Class 2 Driver

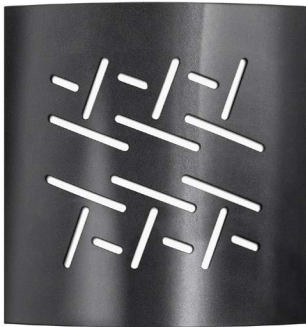

LINE DRAWING

LINE DRAWING NOT TO SCALE

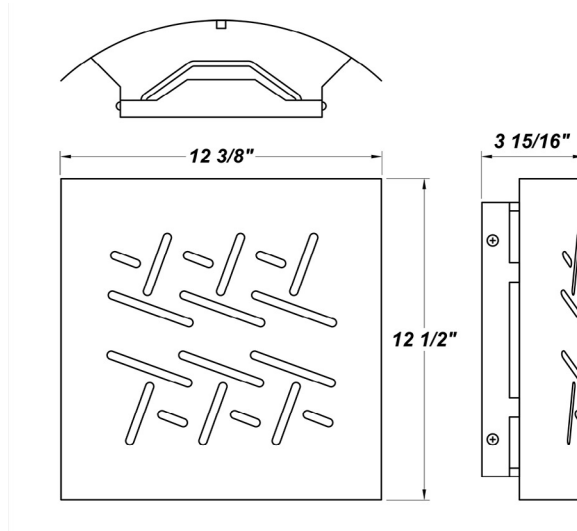

FINISHES

Antique Copper



Antique Silver



Bronze Mist



Matte Silver

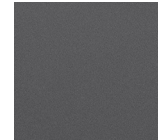

Sand

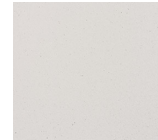

Swedish Steel

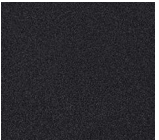

Textured Black

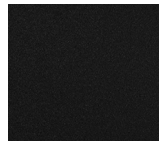

Textured Bronze



Textured White

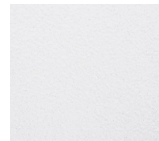

For RAL Colors & Custom Match - Contact Teron Lighting Inc.

CAPRICCIO LED

Architectural Outdoor



Fixture Core

PROJECT:	
TYPE:	
PO#:	QTY:
COMMENTS:	

PRODUCT CODE	SOURCE/WATTAGE	VOLTAGE	DIMMING DRIVER
CPO - Capriccio	L20.0-ZE700 - 20W @ 700mA 0-10V Dimming Driver	120 - 277V (50/60Hz)	Not Applicable
ORDER INFO			
CPO	L20.0-ZE700	120 - 277V	Not Applicable

Example ^ (may not represent a manufacturable product)

Aesthetics & Options

TRIM	FINISH	COLOR TEMP	OPTIONS
Not Applicable	AC - Antique Copper AS - Antique Silver BT - Bronze Mist SM - Matte Silver (Standard) SN - Sand SW - Swedish Steel TB - Textured Black BZ - Textured Bronze TW - Textured White	30K - 3000K Color Temp 35K - 3500K Color Temp 40K - 4000K Color Temp 50K - 5000K Color Temp	F - Fused
ORDER INFO			
Not Applicable	AC	30K	F

Example ^ (may not represent a manufacturable product)

PROD	SOURCE	30K SPECS				
CPO	L20.0	<ul style="list-style-type: none"> 30K - 3000K Color Temp 2000 LED Source Lumens 100 LED Source Lumens Per Watt 				

REPLACEMENT PART	PART NO	NOTES
Frosted White Lens Assembly	38115	

Don't see the configuration you are looking for?
Call us today at (513) 858-6004



TERONLIGHTING.COM
 33 DONALD DR, FAIRFIELD, OH 45014
 P: 513.858.6004 F: 513.858.6038
 E: SALES@TERONLIGHT.COM



We reserve the right to revise the design components of any product due to parts availability or change in UL standards, without assuming any obligation or liability to modify any products previously manufactured, and without notice.