

LANDMARK S LED

Architectural Indoor



PROJECT:	
TYPE:	
PO#:	QTY:
COMMENTS:	



FEATURES

- Steel Trim Accents w/ Matte Silver Powder Coat Finish
- Luminous White Acrylic Diffuser
- Aluminum Mounting Pan & Reflector
- Open Top & Bottom
- Mounts Directly to 4" Junction Box (By Others)
- 120V 350mA Driver is Dimmable
- 277V 350mA Drivers Are Not Dimmable
- Dimmable to <5%
- Dimmable With Either Triac or Electronic Dimmers
- Over-Current, Over-Voltage, and Short Circuit Protection
- Constant Current at 350 Milliamps
- UL Class 2 Driver - Power Factor >.90,
- Estimated 50,000 Hours Life (L70)
- ADA Compliant
- CSA Listed Dry Location For Wall Mounting
- LED Light Fixture
- Mounting Hardware Included

LINE DRAWING

LINE DRAWING NOT TO SCALE

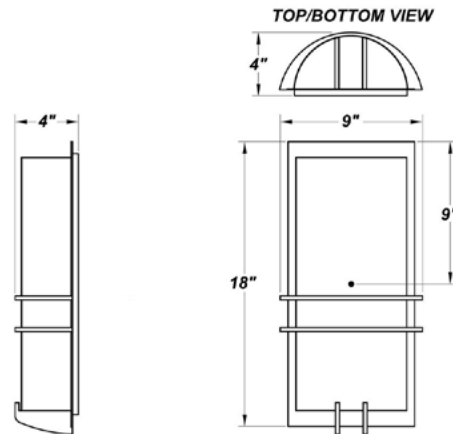

FINISHES

Antique Copper



Antique Silver

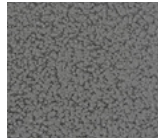

Bronze Mist

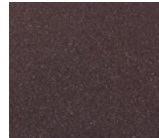

Matte Silver

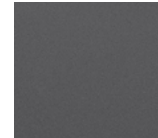

Sand

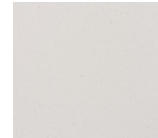

Swedish Steel

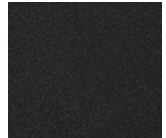

Textured Black



Textured Bronze

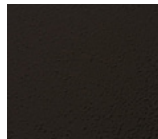

Textured White

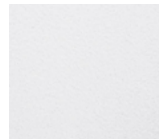

For RAL Colors & Custom Match - Contact Teron Lighting Inc.

LANDMARK S LED

Architectural Indoor



Fixture Core

PROJECT:	
TYPE:	
PO#:	QTY:
COMMENTS:	

PRODUCT CODE	SOURCE/WATTAGE	VOLTAGE	DIMMING DRIVER
LNDS - Landmark S	L25.0-350mA - 25.0W @350mA Constant Current	120V - 120V 277V - 277V (50 / 60Hz)	Not Applicable
ORDER INFO			
LNDS Example ^	L25.0-350mA	120V - 120V	Not Applicable

Aesthetics & Options

TRIM	FINISH	COLOR TEMP	OPTIONS
Not Applicable	AC - Antique Copper AS - Antique Silver BT - Bronze Mist SM - Matte Silver SN - Sand SW - Swedish Steel (Standard) TB - Textured Black BZ - Textured Bronze TW - Textured White	27K - 2700K Color Temp 30K - 3000K Color Temp 35K - 3500K Color Temp 40K - 4000K Color Temp	Not Applicable
ORDER INFO			
Not Applicable Example ^	AC	27K	Not Applicable

PROD	SOURCE	30K SPECS				
LNDS	L25.0	<ul style="list-style-type: none"> 80 CRI Typ. 1615 LED Source Lumens 64.6 LED Source Lumens Per Watt 				

REPLACEMENT PART	PART NO	NOTES
White Acrylic Diffuser	3027860	
		Don't see the configuration you are looking for? Call us today at (513) 858-6004



TERONLIGHTING.COM
 33 DONALD DR, FAIRFIELD, OH 45014
 P: 513.858.6004 F: 513.858.6038
 E: SALES@TERONLIGHT.COM



We reserve the right to revise the design components of any product due to parts availability or change in UL standards, without assuming any obligation or liability to modify any products previously manufactured, and without notice.