

BISCAYNE PRF 25"

Architectural Indoor



PROJECT:	
TYPE:	
PO#:	QTY:
COMMENTS:	



FEATURES

- Steel Housing and End Caps with Matte Silver Powder Coat Finish
- 50% Impact Resistant Frosted DR Acrylic Diffuser
- Steel Reflector Plate with Hi-Reflectance White Powder Coat Finish
- Mounts Directly to Wall or Ceiling with Four Wall Anchors (Not Included)
- ADA Compliant
- CSA Listed Damp Location For Wall or Ceiling Mount
- Emergency Battery Available
- Vandal Resistant



LINE DRAWING

LINE DRAWING NOT TO SCALE

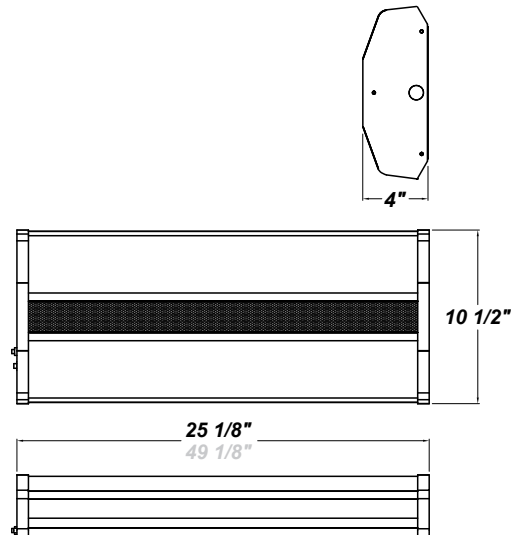

FINISHES

Antique Copper

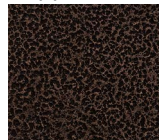

Antique Silver



Bronze Mist



Matte Silver

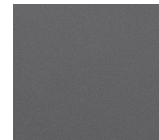

Metallic Black

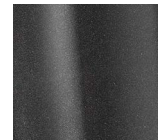

Sand

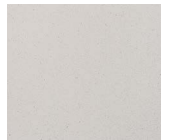

Swedish Steel



Textured Black

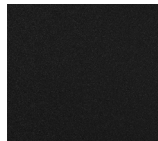

Textured Bronze



Textured White

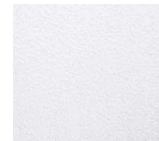

For RAL Colors & Custom Match - Contact Teron Lighting Inc.



BISCAYNE PRF 25"

Architectural Indoor



Fixture Core

PROJECT:	
TYPE:	
PO#:	QTY:
COMMENTS:	

PRODUCT CODE	SOURCE/WATTAGE	VOLTAGE	DIMMING BALLAST
BSC24 - Biscayne 25"	214E - (2) 14W T5 217E - (2) 17W T8 417E - (4) 17W T8 414E - (4) 14W T5 224E-HO - (2) 24W T5 HO (High Output)	120V 277V	Not Applicable
ORDER INFO			
BSC24	214E	120V	Not Applicable

Example ^ (may not represent a manufacturable product)

Aesthetics & Options

TRIM	FINISH	COLOR TEMP	OPTIONS
PRF	AC - Antique Copper AS - Antique Silver BT - Bronze Mist SM - Matte Silver (Standard) MB - Metallic Black SN - Sand SW - Swedish Steel TB - Textured Black BZ - Textured Bronze TW - Textured White	Not Applicable	DIM - Dimming Ballast (Unavailable for HO) EBR - Remote Mount Battery (Field Installed)* EBW - Integral Emergency Battery** F - Fused TP - Tamper Resistant Screws
ORDER INFO			
PRF	AC	Not Applicable	DIM

Example ^ (may not represent a manufacturable product)

REPLACEMENT PART	PART NO	NOTES
Frosted 2' Acrylic Diffuser	3029662	*EBR: Bodine's B94CG (Electronic) - Temperature Rating (Ambient) 32° F - 122° F
White 2' Acrylic Lens Assembly	38112	**EBW: Bodine's B90 (T8 Electronic) / Bodine's LP550 (T5 Electronic) - Temperature Rating (Ambient) 32° F - 122° F
		Emergency Battery Options - Initial light output in Emergency mode will last for a minimum of 90 minutes. 1 lamp wired unless ordered otherwise.
		Don't see the configuration you are looking for? Call us today at (513) 858-6004



TERONLIGHTING.COM
 33 DONALD DR, FAIRFIELD, OH 45014
 P: 513.858.6004 F: 513.858.6038
 E: SALES@TERONLIGHT.COM



We reserve the right to revise the design components of any product due to parts availability or change in UL standards, without assuming any obligation or liability to modify any products previously manufactured, and without notice.