

# VICEROY LG UDL LED 24"

Architectural Indoor



PROJECT:	
TYPE:	
PO#:	QTY:
COMMENTS:	

## FEATURES

- Steel Housing with Matte Silver Powder Coat Finish
- Matte White Acrylic Inner Diffuser
- Clear Acrylic Outer Diffuser
- 0-10V and Trailing Edge (ELV) Dimming Compatible Options Available
- Over-Voltage, Over-Current, and Short-Circuit Protection with Auto Recovery
- Mounts Directly to Surface with Two Wall Anchors (Not Included) Over a 2" Junction Box (Not Included)
- L70 Life Time For 50,000hr
- Knockouts on Back Accept Standard Electrical Fittings (By Others)
- ADA Compliant
- CSA Listed Damp Location For Wall or Ceiling Mount
- Emergency Battery Available
- LED Light Fixture

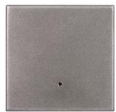

## LINE DRAWING

LINE DRAWING NOT TO SCALE

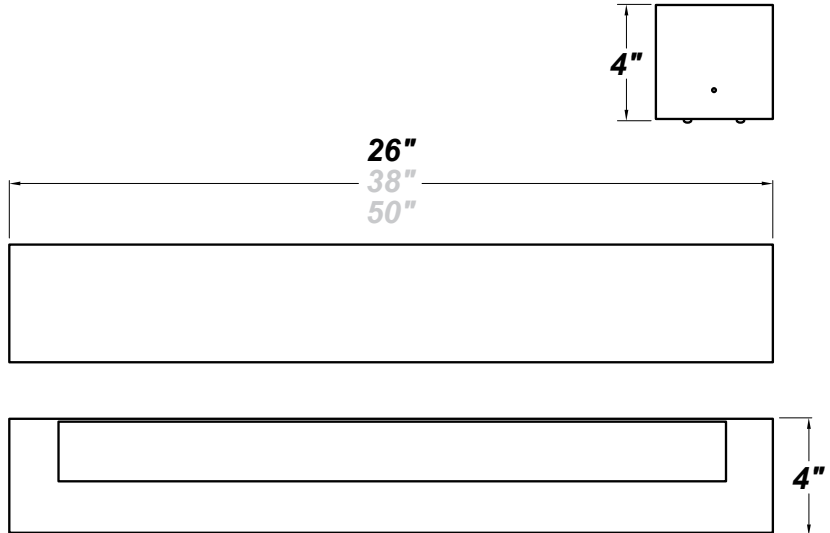

## FINISHES

Antique Copper



Antique Silver

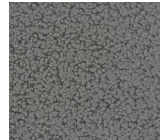

Bronze Mist



Matte Silver

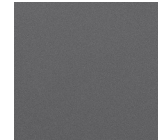

Metallic Black

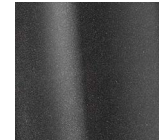

Sand

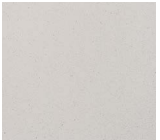

Swedish Steel



Textured Black

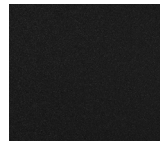

Textured Bronze



Textured White

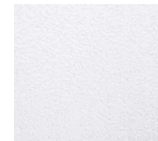

For RAL Colors & Custom Match - Contact Teron Lighting Inc.

# VICEROY LG UDL LED 24"

Architectural Indoor



Fixture Core

PROJECT:	
TYPE:	
PO#:	QTY:
COMMENTS:	

PRODUCT CODE	SOURCE/WATTAGE	VOLTAGE	DIMMING DRIVER
VCYL24 - Viceroy LG 24"	<b>L20.1-TE550</b> - 30W LED Strip(s) @ 550mA ELV Dimming Driver <b>L20.1-ZE550</b> - 22W LED Strip(s) @ 550mA Line Voltage 4-Wire Dimming Driver (Dimmable 0 - 10V)	<b>120-277V</b> <b>347V</b>	<b>Not Applicable</b>
ORDER INFO			
VCYL24 Example ^	L20.1-TE550	120-277V	Not Applicable

Aesthetics & Options

TRIM	FINISH	COLOR TEMP	OPTIONS
UDL	<b>AC</b> - Antique Copper <b>AS</b> - Antique Silver <b>BT</b> - Bronze Mist <b>BZ</b> - Textured Bronze <b>SM</b> - Matte Silver (Standard) <b>MB</b> - Metallic Black <b>SN</b> - Sand <b>SW</b> - Swedish Steel <b>TB</b> - Textured Black <b>TW</b> - Textured White	<b>50K</b> - 5000K Color Temp <b>40K</b> - 4000K Color Temp <b>35K</b> - 3500K Color Temp <b>30K</b> - 3000K Color Temp <b>27K</b> - 2700K Color Temp	<b>EB</b> - Integral Emergency Battery (120V - 277V Only) <b>EBR</b> - Remote Mount Battery (Field Installed) <b>F</b> - Fused (120V / 277V Only) <b>JBC</b> - Junction Box Cover <b>TP</b> - Tamper Resistant Screws
ORDER INFO			
UDL Example ^	AC	50K	EB

PROD	SOURCE	30K SPECS			
VCYL24	L20.1	<ul style="list-style-type: none"> <li>30K - 3000K Color Temp</li> <li>2982 LED Source Lumens</li> <li>148.3 LED Source Lumens Per Watt</li> </ul>			

REPLACEMENT PART	PART NO	NOTES
2' Lens Assembly	38096	

Don't see the configuration you are looking for?  
Call us today at (513) 858-6004



**TERONLIGHTING.COM**  
 33 DONALD DR, FAIRFIELD, OH 45014  
 P: 513.858.6004 F: 513.858.6038  
 E: SALES@TERONLIGHT.COM



We reserve the right to revise the design components of any product due to parts availability or change in UL standards, without assuming any obligation or liability to modify any products previously manufactured, and without notice.