

# TURNBERRY MSI LED 50"

Architectural Indoor

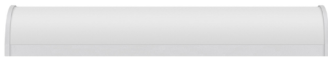

PROJECT:	
TYPE:	
PO#:	QTY:
COMMENTS:	



## FEATURES

- [Internal Motion Sensor](#)
- Die-Formed Steel Housing w/ Textured White Polyester Powder Coat Finish
- Die Cast Aluminum End Caps w/ Textured White Polyester Powder Coat Finish
- High Impact White Acrylic Diffuser (50% DR Acrylic) w/ Inner Frosted Diffuser
- Aluminum LED Mounting Plate
- Recessed Screws
- Fixture Mounts Directly to Surface w/ Two Wall Anchors (Not Included)
- 120V - 277V
- Surge Protector
- ADA Compliant
- CSA Listed Damp Location For Wall or Ceiling Mount
- Emergency Driver Available
- LED Light Fixture

## LINE DRAWING

LINE DRAWING NOT TO SCALE

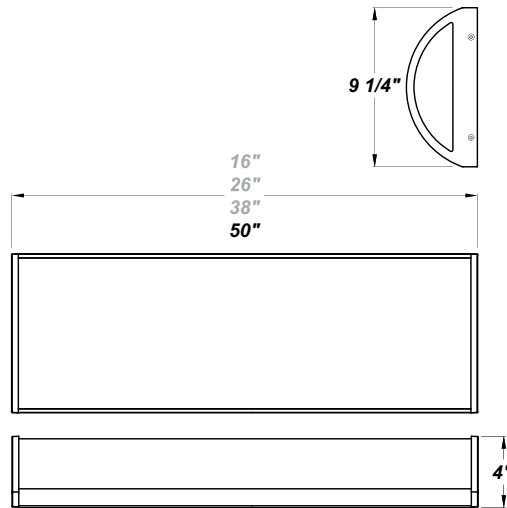

## FINISHES

Antique Copper



Antique Silver



Bronze Mist



Matte Silver

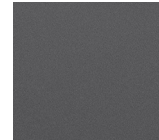

Sand

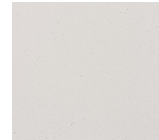

Swedish Steel

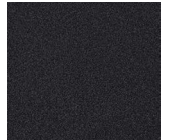

Textured Black

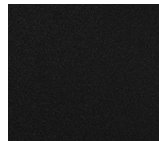

Textured Bronze

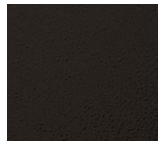

Textured White

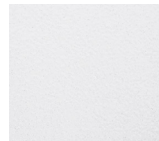

For RAL Colors & Custom Match - Contact Teron Lighting Inc.

# TURNBERRY MSI LED 50"

Architectural Indoor



Fixture Core

PROJECT:	
TYPE:	
PO#:	QTY:
COMMENTS:	

PRODUCT CODE	SOURCE/WATTAGE	VOLTAGE	DIMMING DRIVER
<b>TRN48</b> - Turnberry 50"	<b>L46.0-ZE1400</b> - 46.0W LED Strip(s) @ 1400mA Line Voltage 4-Wire Dimming Driver (Dimmable 0 - 10V) ** <b>L52.0-TE1050</b> - 52.0W LED Strip(s) @ 1050mA ELV Low Voltage 2-Wire Dimming Electronic Driver (Trailing Edge) (347V Only) <b>L60.0-ZE1750</b> - 60.0W LED Strip(s) @ 1750mA Line Voltage 4-Wire Dimming Driver (Dimmable 0 - 10V)	<b>120-277V</b> <b>347V - For 52.0W Only</b> (50 / 60Hz)	<b>Not Applicable</b>
ORDER INFO			
TRN48	L46.0-ZE1400	120-277V	Not Applicable

Example ^ (may not represent a manufacturable product)

Aesthetics & Options

TRIM	FINISH	COLOR TEMP	OPTIONS
<b>Not Applicable</b>	<b>AC</b> - Antique Copper <b>TB</b> - Textured Black <b>AS</b> - Antique Silver <b>BZ</b> - Textured Bronze <b>BT</b> - Bronze Mist <b>TW</b> - Textured White (Standard) <b>SM</b> - Matte Silver <b>SN</b> - Sand <b>SW</b> - Swedish Steel	<b>30K</b> - 3000K Color Temp <b>35K</b> - 3500K Color Temp <b>40K</b> - 4000K Color Temp <b>50K</b> - 5000K Color Temp	<b>EB10</b> - Iota ILB-CP10 10W LED Driver <b>EB12</b> - Iota ILB-CP12 12W LED Driver <b>F</b> - Fused <b>MSI</b> - Steinel HFLUM2-WR Internal Motion Sensor <b>OEL</b> - Single End Window <b>TEL</b> - Twin End Windows (Both Ends) <b>TP</b> - Tamper Resistant Screws
ORDER INFO			
Not Applicable	AC	30K	EB10

Example ^ (may not represent a manufacturable product)

PROD	SOURCE	30K SPECS				
<b>TRN48</b>	L46.0	<ul style="list-style-type: none"> <li>30K - 3000K Color Temp</li> <li>7590 LED Source Lumens</li> <li>165 LED Source Lumens Per Watt</li> </ul>				
	L52.0	<ul style="list-style-type: none"> <li>30K - 3000K Color Temp</li> <li>5693 LED Source Lumens</li> <li>109.5 LED Source Lumens Per Watt</li> </ul>				
	L60.0	<ul style="list-style-type: none"> <li>30K - 3000K Color Temp</li> <li>9788 LED Source Lumens</li> <li>158.1 LED Source Lumens Per Watt</li> </ul>				

REPLACEMENT PART	PART NO	NOTES
4' Acrylic LED Lens Assembly	38218	** EB Option Available
Frosted Polycarbonate End Diffuser (For OEL / TEL)	3410862	

Don't see the configuration you are looking for?  
Call us today at (513) 858-6004



TERONLIGHTING.COM  
 33 DONALD DR, FAIRFIELD, OH 45014  
 P: 513.858.6004 F: 513.858.6038  
 E: SALES@TERONLIGHT.COM



We reserve the right to revise the design components of any product due to parts availability or change in UL standards, without assuming any obligation or liability to modify any products previously manufactured, and without notice.