

BISCAYNE MSE LED 49"

Architectural Indoor



PROJECT:	
TYPE:	
PO#:	QTY:
COMMENTS:	



FEATURES

- [External Motion Sensor](#)
- Steel Housing and End Caps with Matte Silver Powder Coat Finish
- High Impact, Fine Ribbed, Frosted Acrylic Diffuser
- Steel Reflector Plate with Hi-Reflectance White Powder Coat Finish
- Mounts Directly to Wall or Ceiling with Four Wall Anchors (Not Included)
- Standard Ballast Configuration for Motion Sensor is 100% to 0% Up / Down Light
- ADA Compliant
- CSA Listed Damp Location For Wall or Ceiling Mount
- LED Light Fixture
- External Motion Sensor
- Vandal Resistant



LINE DRAWING

LINE DRAWING NOT TO SCALE

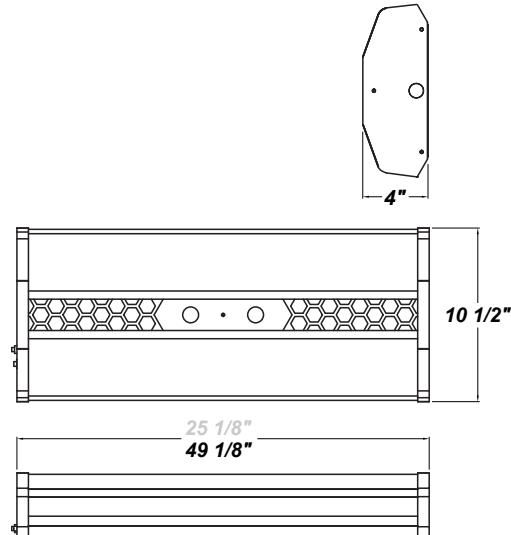

FINISHES

Antique Copper

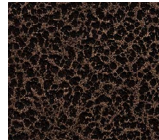

Antique Silver

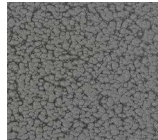

Bronze Mist



Matte Silver

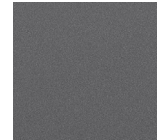

Sand

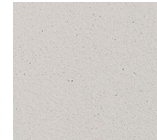

Swedish Steel



Textured Black

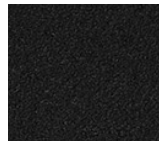

Textured Bronze

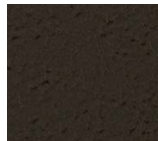

Textured White

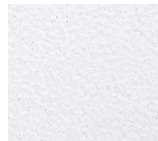

For RAL Colors & Custom Match - Contact Teron Lighting Inc.

BISCAYNE MSE LED 49"

Architectural Indoor



Fixture Core

PROJECT:	
TYPE:	
PO#:	QTY:
COMMENTS:	

PRODUCT CODE	SOURCE/WATTAGE	VOLTAGE	DIMMING BALLAST
BSC48 - Biscayne 49"	L76.7-ZE1050 - 2 x 42W @ 1050mA Constant Current Dimming Electronic Drivers (Dimmable 0-10V) L69.4-TE950 - 2 x 40W @ 950mA Constant Current ELV Dimming Electronic Driver	120V 277V (50 / 60Hz)	SDxx - Bi-Level Step Dimming from 10-90% in increments of 10% (replace xx in ordering code with requested dimming percentage)
ORDER INFO			
BSC48	L76.7-ZE1050	120V	SD50

Example ^ (may not represent a manufacturable product)

Aesthetics & Options

TRIM	FINISH	COLOR TEMP	OPTIONS	
MSE - Watt-Stopper FS505 External Motion Sensor HCB MSE - Honeycomb Pattern w/ External Motion Sensor	DMD MSE - Diamond Pattern w/ External Motion Sensor PRF MSE - Perforated Pattern w/ External Motion Sensor	AC - Antique Copper AS - Antique Silver BT - Bronze Mist SM - Matte Silver (Standard) SN - Sand SW - Swedish Steel TB - Textured Black BZ - Textured Bronze TW - Textured White	27K - 2700K Color Temp. 30K - 3000K Color Temp. 35K - 3500K Color Temp. 40K - 4000K Color Temp. 51K - 5100K Color Temp.	FAL - Frosted Acrylic Lens (Standard) WAL - Frosted & White Acrylic Lens Assembly EB - BSL310 Emergency Driver TP - Tamper Resistant Screws F - Fused
ORDER INFO				
HCB MSE	AC	35K	FAL-WAL	

Example ^ (may not represent a manufacturable product)

PROD	SOURCE	27K SPECS	30K SPECS	35K SPECS	40K SPECS	51K SPECS
BSC48	L76.7-ZE1050	<ul style="list-style-type: none"> 27K - 2700K Color Temp. Nominal 6653 Estimated Delivered Lumens 88.86 Estimated Delivered Lumens Per Watt 	<ul style="list-style-type: none"> 30K - 3000K Color Temp. Nominal 6776 Estimated Delivered Lumens 88.86 Estimated Delivered Lumens Per Watt 	<ul style="list-style-type: none"> 35K - 3500K Color Temp. Nominal 6899 Estimated Delivered Lumens 88.86 Estimated Delivered Lumens Per Watt 	<ul style="list-style-type: none"> 40K - 4000K Color Temp. Nominal 7146 Estimated Delivered Lumens 88.86 Estimated Delivered Lumens Per Watt 	<ul style="list-style-type: none"> 50K - 5000K Color Temp. Nominal 7392 Estimated Delivered Lumens 88.86 Estimated Delivered Lumens Per Watt

REPLACEMENT PART	PART NO	NOTES
Frosted 4' Acrylic Diffuser	3001562	*Don't see the configuration you are looking for? Call us today at (513) 858-6004
White 4' Acrylic Lens Assembly	38113	



TERONLIGHTING.COM
 33 DONALD DR, FAIRFIELD, OH 45014
 P: 513.858.6004 F: 513.858.6038
 E: SALES@TERONLIGHT.COM



We reserve the right to revise the design components of any product due to parts availability or change in UL standards, without assuming any obligation or liability to modify any products previously manufactured, and without notice.

BISCAYNE MSE LED 49"

Architectural Indoor



PROJECT:	
TYPE:	
PO#:	QTY:
COMMENTS:	



Biscayne DMD MSE



Biscayne HCB MSE



Biscayne PRF MSE