

VICEROY LG LED MSE 48"

Architectural Indoor



PROJECT:	
TYPE:	
PO#:	QTY:
COMMENTS:	

FEATURES

- ADA Compliant
- CSA Listed Damp Location For Wall or Ceiling Mount
- [External Motion Sensor](#)
- Knockouts on Back Accept Standard Electrical Fittings (By Others)
- LED Light Fixture
- Matte White Acrylic Inner & Clear Acrylic Outer Lens Assembly
- Mounts Directly to Surface with Two Wall Anchors (Not Included) Over a 2" Junction Box (Not Included)
- Over-Voltage, Over-Current, and Short-Circuit Protection with Auto Recovery
- Steel Housing with Matte Silver Powder Coat Finish



LINE DRAWING

LINE DRAWING NOT TO SCALE

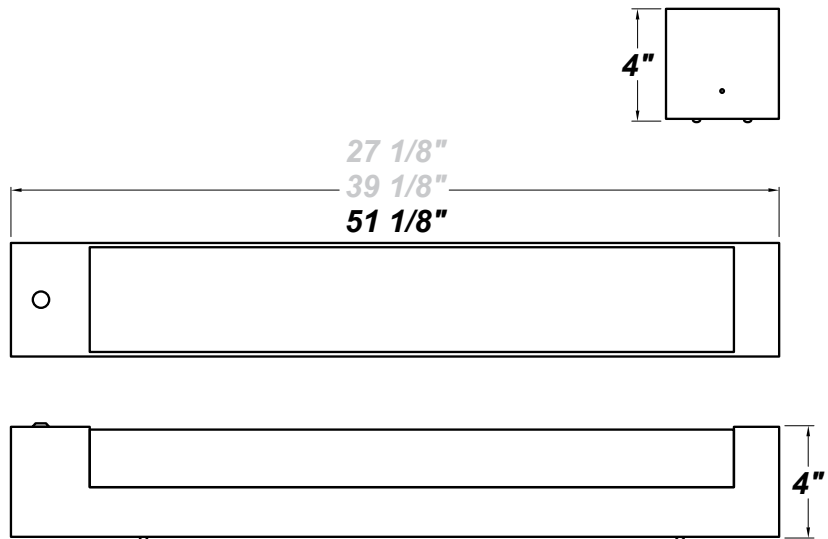

FINISHES

Antique Copper

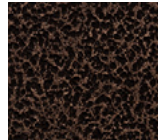

Antique Silver

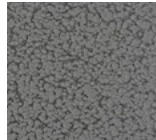

Bronze Mist

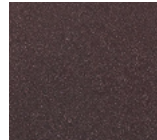

Matte Silver

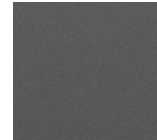

Sand

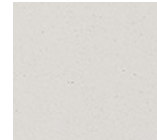

Swedish Steel

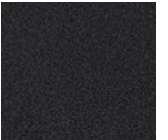

Textured Black

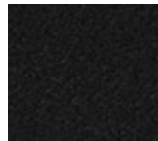

Textured Bronze

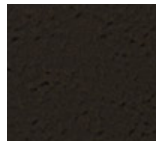

Textured White

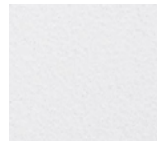

For RAL Colors & Custom Match - Contact Teron Lighting Inc.

VICEROY LG LED MSE 48"

Architectural Indoor



Fixture Core

PROJECT:	
TYPE:	
PO#:	QTY:
COMMENTS:	

PRODUCT CODE	SOURCE/WATTAGE	VOLTAGE	DIMMING BALLAST
VCYL48 - Viceroy LG 48"	L38.3-ZE1050 - 42W @ 1050mA Constant Current Dimming Electronic Driver (Dimmable 0-10V) L34.7-TE950 - 40W @ 950mA Constant Current ELV Dimming Electronic Driver	120V 277V 347V (50 / 60Hz)	SDxx - Bi-Level Step Dimming from 10-70% in increments of 10% (replace xx in ordering code with requested dim to dimming percentage)
ORDER INFO			
VCYL48	L38.3-ZE1050	120V	SD50

Example ^ (may not represent a manufacturable product)

Aesthetics & Options

TRIM	FINISH	COLOR TEMP	OPTIONS
MSE - Wattstopper FS-205 IR Motion Sensor	AC - Antique Copper AS - Antique Silver BT - Bronze Mist SM - Matte Silver (Standard) SN - Sand SW - Swedish Steel TB - Textured Black BZ - Textured Bronze TW - Textured White	30K - 3000K Color Temp. 35K - 3500K Color Temp. 40K - 4000K Color Temp. 50K - 5000K Color Temp.	JBC - 4" x 4" Junction Box Cover (Mounts to Fixture, To be Retro-fitted Over an Existing Junction Box) EB - BSL310 Emergency Driver, TP - Tamper Resistant Screws, F - Fused
ORDER INFO			
MSE	AC	35K	JBC

Example ^ (may not represent a manufacturable product)

PROD	SOURCE	30K SPECS	35K SPECS	40K SPECS	50K SPECS
VCYL48	L38.3-ZE1050	<ul style="list-style-type: none"> • 30K - 3000K Color Temp. Nominal • 3381 Estimated Delivered Lumens • 44.21 Estimated Delivered Lumens Per Watt 	<ul style="list-style-type: none"> • 35K - 3500K Color Temp. Nominal • 3442 Estimated Delivered Lumens • 44.21 Estimated Delivered Lumens Per Watt 	<ul style="list-style-type: none"> • 40K - 4000K Color Temp. Nominal • 3565 Estimated Delivered Lumens • 44.21 Estimated Delivered Lumens Per Watt 	<ul style="list-style-type: none"> • 50K - 5000K Color Temp. Nominal • 3688 Estimated Delivered Lumens • 44.21 Estimated Delivered Lumens Per Watt

REPLACEMENT PART	PART NO	NOTES
4' Lens Assembly	38098	*Don't see the configuration you are looking for? Call us today at (513) 858-6004



TERONLIGHTING.COM
 33 DONALD DR, FAIRFIELD, OH 45014
 P: 513.858.6004 F: 513.858.6038
 E: SALES@TERONLIGHT.COM



We reserve the right to revise the design components of any product due to parts availability or change in UL standards, without assuming any obligation or liability to modify any products previously manufactured, and without notice.