

OASIS MSE LED 48"

Architectural Indoor



PROJECT:	
TYPE:	
PO#:	QTY:
COMMENTS:	

FEATURES

- [External Motion Sensor](#)
- Steel Housing w/ White Powder Coat Finish
- Steel Mounting Pan w/ Hi-Reflectance White Powder Coat Finish
- Steel End Caps w/ White Powder Coat Finish
- Clear Acrylic Lens w/ Ribbed Sides and Prismatic Front
- Mounts Directly to Surface w/ Two Wall Anchors (Not Included)
- 0-10V and Leading Edge / Phase Dimming Compatible Options Available
- IES Files Available
- CSA Listed Damp Location
- Emergency Battery Available
- LED Light Fixture



LINE DRAWING

LINE DRAWING NOT TO SCALE

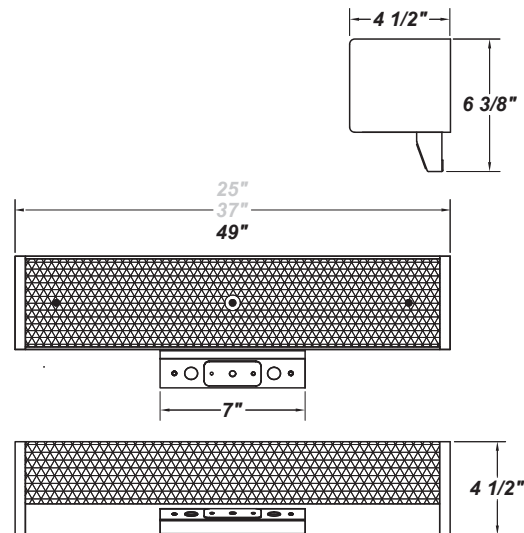

FINISHES

Antique Copper



Antique Silver

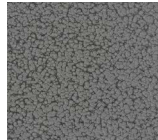

Bronze Mist



Gloss White

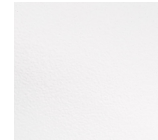

Matte Silver

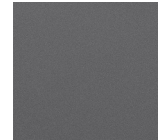

Metallic Black

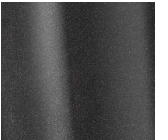

Sand

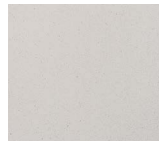

Swedish Steel



Textured Black

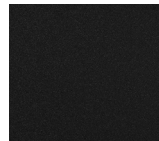

Textured Bronze



Textured White

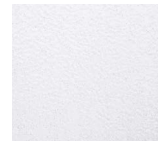

For RAL Colors & Custom Match - Contact Teron Lighting Inc.



OASIS MSE LED 48"

Architectural Indoor



Fixture Core

PROJECT:	
TYPE:	
PO#:	QTY:
COMMENTS:	

PRODUCT CODE	SOURCE/WATTAGE	VOLTAGE	DIMMING DRIVER
OAS48 - Oasis 48"	L69.4-LE1900 - 69.4W @ 1900mA Triac Dimming Driver L69.4-ZE1900 - 69.4W @ 1900mA Line Voltage 4-Wire Dimming Driver (Dimmable 0 - 10V)	120 - 277V 347V (50 / 60Hz)	SD10 - 10/100% Bi-level Step Dimming SD25 - 25/100% Bi-level Step Dimming (120V / 277V Only) SD50 - 50/100% Bi-level Step Dimming (120V / 277V Only)
ORDER INFO			
OAS48 Example ^	L69.4-LE1900	120 - 277V	SD10

Aesthetics & Options

TRIM	FINISH	COLOR TEMP	OPTIONS
MSE	AC - Antique Copper AS - Antique Silver BT - Bronze Mist BN - Brushed Nickel SM - Matte Silver MB - Metallic Black SN - Sand SW - Swedish Steel TB - Textured Black BZ - Textured Bronze TW - Textured White WH - Gloss White (Standard)	27K - 2700K Color Temp 30K - 3000K Color Temp 35K - 3500K Color Temp 40K - 4000K Color Temp 50K - 5000K Color Temp	2SW - 2-Position Switch w/ Pull Chain* BFL - Front Baffle For Up / Down Lighting CH - Chrome End Caps CO - Convenience Outlet* EB - Integral Emergency Battery** F - Fused** MSW - Multi-Level Switch w/ Pull Chain (120V Only) (For Multi-Directional Lighting)* NLT - 5.1W LED Night Light** SP - Surge Protector
ORDER INFO			
MSE Example ^	AC	27K	2SW

PROD	SOURCE	30K SPECS			
OAS 48"	L69.4	<ul style="list-style-type: none"> 30K - 3000K Color Temp 8028 LED Source Lumens 100.4 LED Source Lumens Per Watt 			

REPLACEMENT PART	PART NO	NOTES
48" Clear Acrylic Diffuser	30904	* Option is for 120V Only ** Option is for 120 or 277V Only

Don't see the configuration you are looking for?
Call us today at (513) 858-6004



TERONLIGHTING.COM
 33 DONALD DR, FAIRFIELD, OH 45014
 P: 513.858.6004 F: 513.858.6038
 E: SALES@TERONLIGHT.COM



We reserve the right to revise the design components of any product due to parts availability or change in UL standards, without assuming any obligation or liability to modify any products previously manufactured, and without notice.