

OASIS MSE LED 36"

Architectural Indoor



PROJECT:	
TYPE:	
PO#:	QTY:
COMMENTS:	

FEATURES

- [External Motion Sensor](#)
- Steel Housing w/ White Powder Coat Finish
- Steel Mounting Pan w/ Hi-Reflectance White Powder Coat Finish
- Steel End Caps w/ White Powder Coat Finish
- Clear Acrylic Lens w/ Ribbed Sides and Prismatic Front
- Mounts Directly to Surface w/ Two Wall Anchors (Not Included)
- 0-10V and Leading Edge / Phase Dimming Compatible Options Available
- IES Files Available
- CSA Listed Damp Location
- Emergency Battery Available
- LED Light Fixture



LINE DRAWING

LINE DRAWING NOT TO SCALE

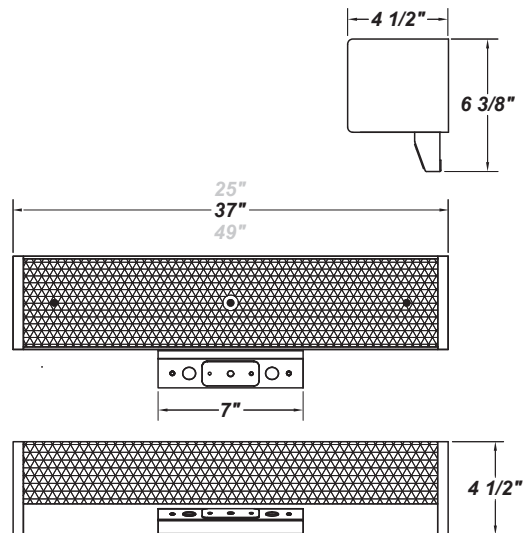

FINISHES

Antique Copper



Antique Silver

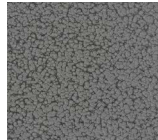

Bronze Mist



Gloss White

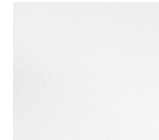

Matte Silver

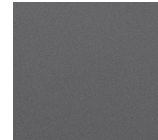

Metallic Black

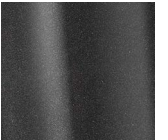

Sand

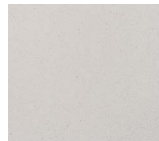

Swedish Steel



Textured Black

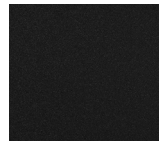

Textured Bronze



Textured White

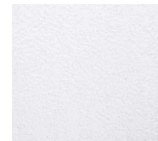

For RAL Colors & Custom Match - Contact Teron Lighting Inc.

OASIS MSE LED 36"

Architectural Indoor



Fixture Core

PROJECT:	
TYPE:	
PO#:	QTY:
COMMENTS:	

PRODUCT CODE	SOURCE/WATTAGE	VOLTAGE	DIMMING DRIVER
OAS36 - Oasis 36"	L43.5-LE1280 - 43.5W @ 1280mA Triac Dimming Driver* L51.0-ZE1500 - 51.0W @ 1500mA Line Voltage 4-Wire Dimming Driver (Dimmable 0 - 10V)(347V Only)	120 - 277V 347V (50 / 60Hz)	SD10 - 10/100% Bi-level Step Dimming SD25 - 25/100% Bi-level Step Dimming (120V / 277V Only) SD50 - 50/100% Bi-level Step Dimming (120V / 277V Only)
ORDER INFO			
OAS36 Example ^	L43.5-LE1280	120 - 277V	SD10

Aesthetics & Options

TRIM	FINISH	COLOR TEMP	OPTIONS
MSE	AC - Antique Copper AS - Antique Silver BT - Bronze Mist BN - Brushed Nickel SM - Matte Silver MB - Metallic Black SN - Sand SW - Swedish Steel TB - Textured Black BZ - Textured Bronze TW - Textured White WH - Gloss White (Standard)	27K - 2700K Color Temp 30K - 3000K Color Temp 35K - 3500K Color Temp 40K - 4000K Color Temp 50K - 5000K Color Temp	2SW - 2-Position Switch w/ Pull Chain* BFL - Front Baffle For Up / Down Lighting CH - Chrome End Caps CO - Convenience Outlet* EB - Integral Emergency Battery** F - Fused** MSW - Multi-Level Switch w/ Pull Chain (120V Only) (For Multi-Directional Lighting)* NLT - 5.1W LED Night Light** SP - Surge Protector
ORDER INFO			
MSE Example ^	AC	27K	2SW

PROD	SOURCE	30K SPECS			
OAS 36"	L43.5	<ul style="list-style-type: none"> 30K - 3000K Color Temp 5150 LED Source Lumens 125.6 LED Source Lumens Per Watt 			
	L51.0	<ul style="list-style-type: none"> 30K - 3000K Color Temp 7450 LED Source Lumens 146.1 LED Source Lumens Per Watt 			

REPLACEMENT PART	PART NO	NOTES
36" Clear Acrylic Diffuser	30907	* Option is for 120V Only ** Option is for 120 or 277V Only
		Don't see the configuration you are looking for? Call us today at (513) 858-6004



TERONLIGHTING.COM
 33 DONALD DR, FAIRFIELD, OH 45014
 P: 513.858.6004 F: 513.858.6038
 E: SALES@TERONLIGHT.COM



We reserve the right to revise the design components of any product due to parts availability or change in UL standards, without assuming any obligation or liability to modify any products previously manufactured, and without notice.

OASIS MSE LED 36"

Architectural Indoor



Fixture Core

PROJECT:	
TYPE:	
PO#:	QTY:
COMMENTS:	

PRODUCT CODE	SOURCE/WATTAGE	VOLTAGE	DIMMING DRIVER
OAS36 - Oasis 36"	L54.4-LE1600 - 54.4W @ 1600mA Triac Dimming Driver* L54.4-ZE1600 - 54.4W @ 1600mA Line Voltage 4-Wire Dimming Driver (Dimmable 0 - 10V)	120 - 277V 347V (50 / 60Hz)	SD10 - 10/100% Bi-level Step Dimming SD25 - 25/100% Bi-level Step Dimming (120V / 277V Only) SD50 - 50/100% Bi-level Step Dimming (120V / 277V Only)
ORDER INFO			
OAS36 Example ^	L54.4-LE1600	120 - 277V	SD10

Aesthetics & Options

TRIM	FINISH	COLOR TEMP	OPTIONS
MSE	AC - Antique Copper TB - Textured Black AS - Antique Silver BT - Bronze Mist BZ - Textured Bronze BN - Brushed Nickel TW - Textured White SM - Matte Silver MB - Metallic Black WH - Gloss White (Standard) SN - Sand SW - Swedish Steel	27K - 2700K Color Temp 30K - 3000K Color Temp 35K - 3500K Color Temp 40K - 4000K Color Temp 50K - 5000K Color Temp	2SW - 2-Position Switch w/ Pull Chain* BFL - Front Baffle For Up / Down Lighting CH - Chrome End Caps CO - Convenience Outlet* EB - Integral Emergency Battery** F - Fused** MSW - Multi-Level Switch w/ Pull Chain (120V Only) (For Multi-Directional Lighting)* NLT - 5.1W LED Night Light** SP - Surge Protector
ORDER INFO			
MSE Example ^	AC	27K	2SW

PROD	SOURCE	30K SPECS			
OAS 36"	L54.4	<ul style="list-style-type: none"> • 30K - 3000K Color Temp • 7802 LED Source Lumens • 123.8 LED Source Lumens Per Watt 			

REPLACEMENT PART	PART NO	NOTES
36" Clear Acrylic Diffuser	30907	* Option is for 120V Only ** Option is for 120 or 277V Only

Don't see the configuration you are looking for?
Call us today at (513) 858-6004



TERONLIGHTING.COM
 33 DONALD DR, FAIRFIELD, OH 45014
 P: 513.858.6004 F: 513.858.6038
 E: SALES@TERONLIGHT.COM



We reserve the right to revise the design components of any product due to parts availability or change in UL standards, without assuming any obligation or liability to modify any products previously manufactured, and without notice.