

GUARDIAN W MSI LED 26"

Architectural Outdoor



| | |
|-----------|------|
| PROJECT: | |
| TYPE: | |
| PO#: | QTY: |
| COMMENTS: | |



FEATURES

- [Internal Motion Sensor](#)
- Extruded Aluminum Housing w/ Matte Silver Polyester Powder Coat Finish
- Die Cast Aluminum End Caps w/ Matte Silver Polyester Powder Coat Finish
- High Impact White Acrylic Diffuser (50% DR Acrylic)
- Aluminum Reflector w/ Hi-Reflectance White Powder Coat Finish
- Recessed Steel Screws
- Fixture Mounts Directly to Surface w/ Two Wall Anchors (Not Included)
- Over-Voltage and Over-Current
- 120V - 277V
- ADA Compliant
- CSA Listed Wet Location For Wall Mount Only
- LED Light Fixture

LINE DRAWING

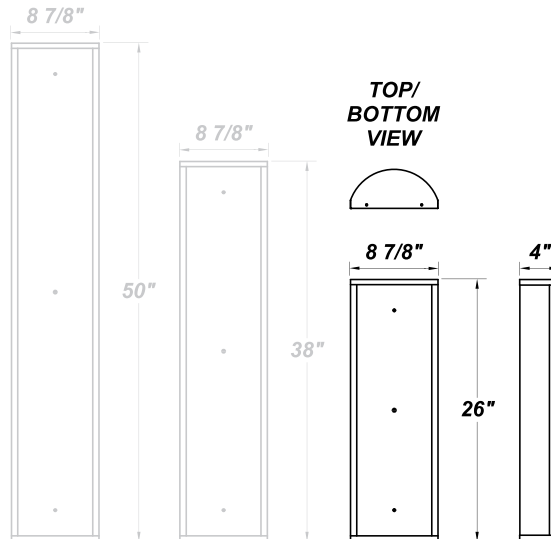

FINISHES

Antique Copper

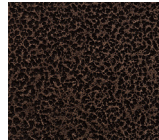

Antique Silver

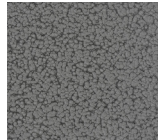

Bronze Mist

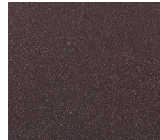

Matte Silver

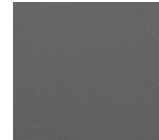

Sand



Swedish Steel

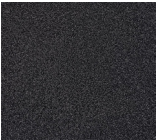

Textured Black

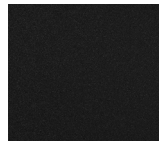

Textured Bronze

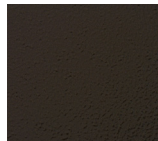

Textured White

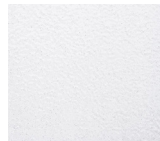

For RAL Colors & Custom Match - Contact Teron Lighting Inc.

GUARDIAN W MSI LED 26"

Architectural Outdoor



Fixture Core

| | |
|-----------|------|
| PROJECT: | |
| TYPE: | |
| PO#: | QTY: |
| COMMENTS: | |

| PRODUCT CODE | SOURCE/WATTAGE | VOLTAGE | DIMMING BALLAST |
|--------------------------------|-------------------------------------------------------------------------------------------------------------|----------------------------|--------------------------------------------------------------------------------------------------------------------------------------|
| GRDW24 - Guardian W 26" | L36.5 - 36.5W LED Strip(s) L46.5 - 46.5W LED Strip(s) L49.5 - 49.5W LED Strip(s) | 120V 277V | SDxx - Bi-Level Step Dimming from 10-90% in increments of 10% (replace xx in ordering code with requested dimming percentage) |
| ORDER INFO | | | |
| GRDW24 | L36.5 | 120 | SD50 |

Example ^ (may not represent a manufacturable product)

Aesthetics & Options

| TRIM | FINISH | COLOR TEMP | OPTIONS |
|------------|------------------------------------------------------------------------------------------------------------------------------------------------------------------------------------------------------------------------------------------------------------------------|----------------------------------------------------------------------------------------------------|----------------------------------------------------------------------------------------------------------------|
| MSI | AC - Antique Copper AS - Antique Silver BT - Bronze Mist SM - Matte Silver (Standard) SN - Sand SW - Swedish Steel TB - Textured Black BZ - Textured Bronze TW - Textured White | 30K - 3000K Color Temp. 35K - 3500K Color Temp. 40K - 4000K Color Temp. | WAL - White Acrylic Lens OEL - Single End Window TEL - Twin End Windows (Both Ends) |
| ORDER INFO | | | |
| MSI | AC | 30K | WAL |

Example ^ (may not represent a manufacturable product)

| PROD | SOURCE | 30K SPECS | 35K SPECS | 40K SPECS |
|---------------|---------------------------------------|---------------------------------------------------------------------------------------------------------------------------------------------------------------------|---------------------------------------------------------------------------------------------------------------------------------------------------------------------|----------------------------------------------------------------------------------------------------------------------------------------------------------------------|
| GRDW24 | L36.5 - 36.5W LED Linear Board | <ul style="list-style-type: none"> 34 fV, Color Temp = 3000K Nominal 36.9W Input = 4898 LED Lumens Estimated 132.7 Lumens Per Watt | <ul style="list-style-type: none"> 34 fV, Color Temp = 3500K Nominal 36.9W Input = 4987 LED Lumens Estimated 135.1 Lumens Per Watt | <ul style="list-style-type: none"> 34 fV, Color Temp = 4000K Nominal 36.9W Input = 5165 LED Lumens Estimated 140 Lumens Per Watt |
| | L46.5 - 46.5W LED Linear Board | <ul style="list-style-type: none"> 34 fV, Color Temp = 3000K Nominal 38.8W Input = 5064 LED Lumens Estimated 130.5 Lumens Per Watt | <ul style="list-style-type: none"> 34 fV, Color Temp = 3500K Nominal 38.8W Input = 5155 LED Lumens Estimated 132.9 Lumens Per Watt | <ul style="list-style-type: none"> 34 fV, Color Temp = 4000K Nominal 38.8W Input = 55340 LED Lumens Estimated 137.6 Lumens Per Watt |
| | L49.5 - 49.5W LED Linear Board | <ul style="list-style-type: none"> 34 fV, Color Temp = 3000K Nominal 40.7W Input = 5156 LED Lumens Estimated 126.7 Lumens Per Watt | <ul style="list-style-type: none"> 34 fV, Color Temp = 3500K Nominal 40.7W Input = 5250 LED Lumens Estimated 129 Lumens Per Watt | <ul style="list-style-type: none"> 34 fV, Color Temp = 4000K Nominal 40.7W Input = 5437 LED Lumens Estimated 133.6 Lumens Per Watt |

| REPLACEMENT PART | PART NO | NOTES |
|------------------------------|---------|-----------------------------------------------------------------------------------|
| 2' Acrylic LED Lens Assembly | 38216 | *Don't see the configuration you are looking for? Call us today at (513) 858-6004 |



TERONLIGHTING.COM
 33 DONALD DR, FAIRFIELD, OH 45014
 P: 513.858.6004 F: 513.858.6038
 E: SALES@TERONLIGHT.COM



We reserve the right to revise the design components of any product due to parts availability or change in UL standards, without assuming any obligation or liability to modify any products previously manufactured, and without notice.