

GUARDIAN W MSI LED 26"

Architectural Outdoor



PROJECT:	
TYPE:	
PO#:	QTY:
COMMENTS:	

FEATURES

- 120V - 277V
- Aluminum Reflector w/ Hi-Reflectance White Powder Coat Finish
- CSA Listed Wet Location For Wall Mount Only
- Die Cast Aluminum End Caps w/ Matte Silver Polyester Powder Coat Finish
- Extruded Aluminum Housing w/ Matte Silver Polyester Powder Coat Finish
- Fixture Mounts Directly to Surface w/ Two Wall Anchors (Not Included)
- High Impact White Acrylic Diffuser (50% DR Acrylic)
- Internal Motion Sensor
- LED Light Fixture
- Over-Voltage and Over-Current
- Recessed Steel Screws

LINE DRAWING

LINE DRAWING NOT TO SCALE

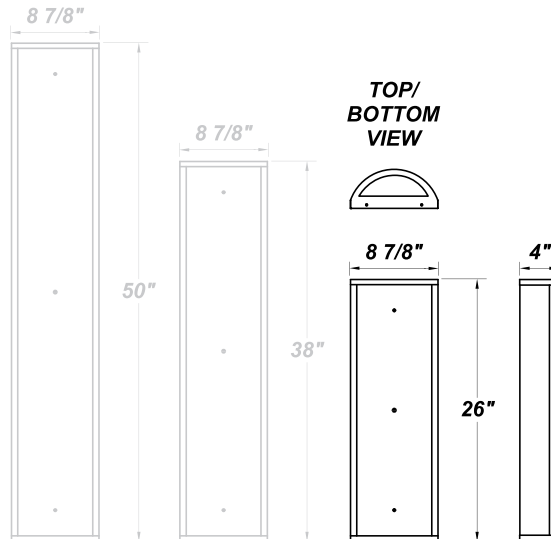

FINISHES

Antique Copper



Antique Silver



Bronze Mist



Matte Silver

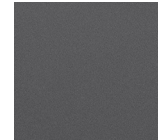

Sand

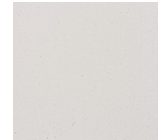

Swedish Steel

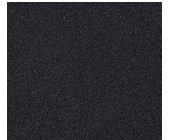

Textured Black

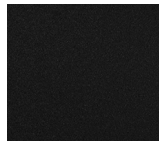

Textured Bronze

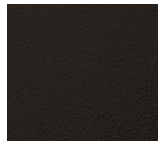

Textured White

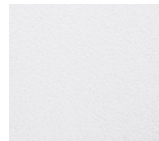

For RAL Colors & Custom Match - Contact Teron Lighting Inc.

GUARDIAN W MSI LED 26"

Architectural Outdoor



Fixture Core

PROJECT:	
TYPE:	
PO#:	QTY:
COMMENTS:	

PRODUCT CODE	SOURCE/WATTAGE	VOLTAGE	DIMMING DRIVER
GRDW24 - Guardian W 26"	L36.5 - 36.5W LED Strip(s) L46.5 - 46.5W LED Strip(s) L49.5 - 49.5W LED Strip(s)	120 277V	SDxx - Bi-Level Step Dimming from 10-90% in increments of 10% (replace xx in ordering code with requested dimming percentage)
ORDER INFO			
GRDW24	L36.5	120V	SD50

Example ^ (may not represent a manufacturable product)

Aesthetics & Options

TRIM	FINISH	COLOR TEMP	OPTIONS
Not Applicable	AC - Antique Copper AS - Antique Silver BT - Bronze Mist SM - Matte Silver (Standard) SN - Sand SW - Swedish Steel TB - Textured Black BZ - Textured Bronze TW - Textured White	30K - 3000K Color Temp 35K - 3500K Color Temp 40K - 4000K Color Temp	OEL - Single End Window TEL - Twin End Windows (Both Ends) WAL - White Acrylis Lens
ORDER INFO			
	AC	30K	OEL

Example ^ (may not represent a manufacturable product)

PROD	SOURCE	30K SPECS	35K SPECS	40K SPECS
GRDW24	L36.5 - 36.5W LED Linear Board	<ul style="list-style-type: none"> 34 fV, Color Temp = 3000K Nominal 36.9W Input = 4898 LED Lumens Estimated 132.7 Lumens Per Watt 	<ul style="list-style-type: none"> 34 fV, Color Temp = 3500K Nominal 36.9W Input = 4987 LED Lumens Estimated 135.1 Lumens Per Watt 	<ul style="list-style-type: none"> 34 fV, Color Temp = 4000K Nominal 36.9W Input = 5165 LED Lumens Estimated 140 Lumens Per Watt
	L46.5 - 46.5W LED Linear Board	<ul style="list-style-type: none"> 34 fV, Color Temp = 3000K Nominal 38.8W Input = 5064 LED Lumens Estimated 130.5 Lumens Per Watt 	<ul style="list-style-type: none"> 34 fV, Color Temp = 3500K Nominal 38.8W Input = 5155 LED Lumens Estimated 132.9 Lumens Per Watt 	<ul style="list-style-type: none"> 34 fV, Color Temp = 4000K Nominal 38.8W Input = 55340 LED Lumens Estimated 137.6 Lumens Per Watt
	L49.5 - 49.5W LED Linear Board	<ul style="list-style-type: none"> 34 fV, Color Temp = 3000K Nominal 40.7W Input = 5156 LED Lumens Estimated 126.7 Lumens Per Watt 	<ul style="list-style-type: none"> 34 fV, Color Temp = 3500K Nominal 40.7W Input = 5250 LED Lumens Estimated 129 Lumens Per Watt 	<ul style="list-style-type: none"> 34 fV, Color Temp = 4000K Nominal 40.7W Input = 5437 LED Lumens Estimated 133.6 Lumens Per Watt

REPLACEMENT PART	PART NO	NOTES
2' Acrylic LED Lens Assembly	38216	*Don't see the configuration you are looking for? Call us today at (513) 858-6004



TERONLIGHTING.COM
 33 DONALD DR, FAIRFIELD, OH 45014
 P: 513.858.6004 F: 513.858.6038
 E: SALES@TERONLIGHT.COM



We reserve the right to revise the design components of any product due to parts availability or change in UL standards, without assuming any obligation or liability to modify any products previously manufactured, and without notice.