

# ALLERO MSE LED 49"

Architectural Indoor



PROJECT:	
TYPE:	
PO#:	QTY:
COMMENTS:	

## FEATURES

- [External Motion Sensor](#)
- Steel Housing & End Caps with Matte Silver Powder Coat Finish & light Reducing Solid Top
- High Impact Frosted Acrylic Diffuser
- Steel Reflector Plate with Hi-Reflectance White Powder Coat Finish
- Mounts Directly to Wall or Ceiling with Four Wall Anchors (Not Included)
- Constant Current
- Dimmable 0-10V, 10-90% Bi-Level Step Dimming - 10% increments
- IES Files Available (Tested with Standard White Acrylic Lens Assembly)
- Optional Mounting of Luminaire - Directing The LEDs 20 Degrees From Horizontal or 70 Degrees From Horizontal (FS-505 Recommended in Standard Mounting Position Only)
- ADA Compliant
- CSA Listed Damp Location For Wall or Ceiling Mount
- LED Light Fixture



## LINE DRAWING

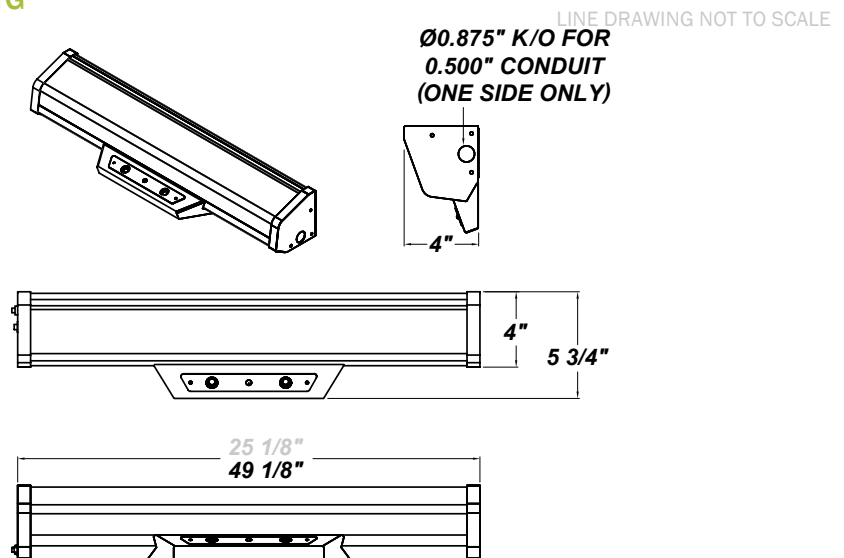

## FINISHES

Antique Copper

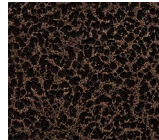

Antique Silver

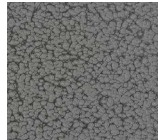

Bronze Mist



Matte Silver

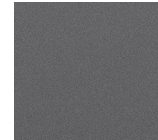

Sand

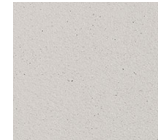

Swedish Steel



Textured Black

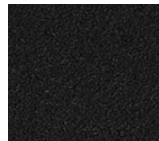

Textured Bronze

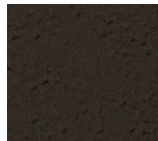

Textured White

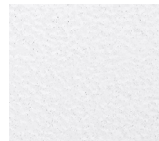

For RAL Colors & Custom Match - Contact Teron Lighting Inc.

# ALLERO MSE LED 49"

Architectural Indoor



Fixture Core

PROJECT:	
TYPE:	
PO#:	QTY:
COMMENTS:	

PRODUCT CODE	SOURCE/WATTAGE	VOLTAGE	DIMMING BALLAST
<b>ALO48</b> - Allero 49"	<b>L38.3-ZE1050</b> - 42W @ 1050mA Constant Current Dimming Electronic Driver (Dimmable 0-10V)  <b>L34.7-TE950</b> - 40W @ 950mA Constant Current ELV Dimming Electronic Driver	<b>120V</b> <b>277V</b> <b>347V</b> (50 / 60Hz)	<b>SDxx</b> - Bi-Level Step Dimming from 10-90% in increments of 10% (replace xx in ordering code with requested dimming percentage)
ORDER INFO			
ALO48	L38.3-ZE1050	120V	SD50

Example ^ (may not represent a manufacturable product)

Aesthetics & Options

TRIM	FINISH	COLOR TEMP	OPTIONS
<b>MSE</b> - External Motion Sensor (Wattstopper FS-505)	<b>AC</b> - Antique Copper <b>AS</b> - Antique Silver <b>BT</b> - Bronze Mist <b>SM</b> - Matte Silver (Standard) <b>SN</b> - Sand <b>SW</b> - Swedish Steel <b>TB</b> - Textured Black <b>BZ</b> - Textured Bronze <b>TW</b> - Textured White	<b>51K</b> - 5100K Color Temp. <b>40K</b> - 4000K Color Temp. <b>35K</b> - 3500K Color Temp. <b>30K</b> - 3000K Color Temp. <b>27K</b> - 2700K Color Temp.	<b>FAL</b> - Frosted Acrylic Lens <b>WAL</b> - White Acrylic Lens Assembly (Standard) <b>EB</b> - BSL310LP Emergency Driver (120V - 277V Only) <b>TP</b> - Tamper Resistant Screws <b>F</b> - Fused
ORDER INFO			
MSE	AC	51K	FAL-WAL

Example ^ (may not represent a manufacturable product)

PROD	SOURCE					

REPLACEMENT PART	PART NO	NOTES
Frosted 4' Acrylic Diffuser	3001562	*Don't see the configuration you are looking for? Call us today at (513) 858-6004
White 4' Acrylic Lens Assembly	38113	



**TERONLIGHTING.COM**  
 33 DONALD DR, FAIRFIELD, OH 45014  
 P: 513.858.6004 F: 513.858.6038  
 E: SALES@TERONLIGHT.COM



We reserve the right to revise the design components of any product due to parts availability or change in UL standards, without assuming any obligation or liability to modify any products previously manufactured, and without notice.