

# MYRTLE BEACH II LED

Architectural Indoor



PROJECT:		
TYPE:		
PO#:		QTY:
COMMENTS:		

## FEATURES

- Aluminum Mounting Pan and Stems w/ Matte Silver Powder Coat Finish
- CSA Listed Damp Location
- LED Light Fixture
- Luminous White Acrylic Diffuser
- Mounting Hardware Included
- Mounts Directly to 4" Junction Box (By Others)

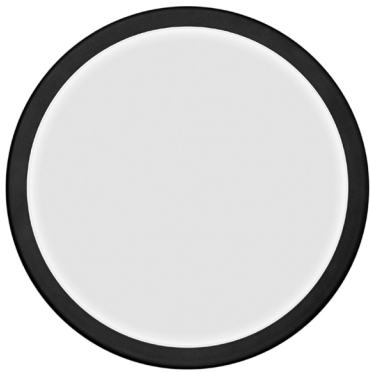

## LINE DRAWING

LINE DRAWING NOT TO SCALE

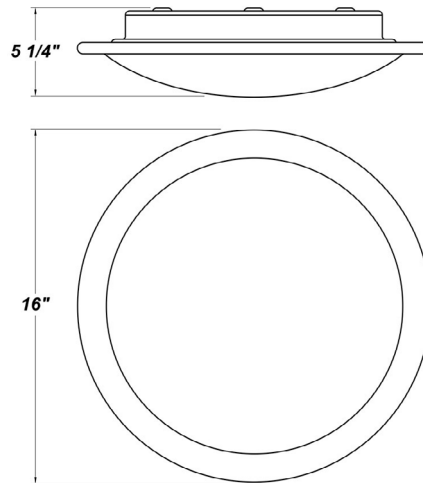

## FINISHES

Antique Copper



Antique Silver



Bronze Mist



Matte Silver

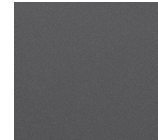

Sand

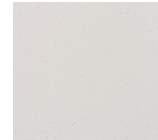

Swedish Steel

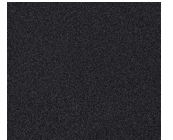

Textured Black

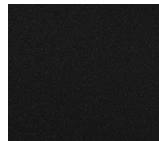

Textured Bronze

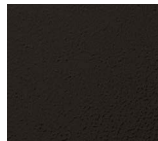

Textured White

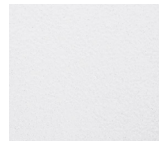

For RAL Colors & Custom Match - Contact Teron Lighting Inc.

# MYRTLE BEACH II LED

Architectural Indoor



Fixture Core

PROJECT:	
TYPE:	
PO#:	QTY:
COMMENTS:	

PRODUCT CODE	SOURCE/WATTAGE	VOLTAGE	DIMMING DRIVER
MHT - Myrtle Beach II	<b>L13.0-ZE560</b> - (48) LED Array @ Line Voltage 4-Wire Dimming Driver (Dimmable 0 - 10V) <b>L16.3-ZE560</b> - (60) LED Array @ Line Voltage 4-Wire Dimming Driver (Dimmable 0 - 10V) <b>L21.0-ZE700</b> - (60) LED Array @ Line Voltage 4-Wire Dimming Driver (Dimmable 0 - 10V)	<b>120V - 277V</b> (50 / 60Hz)	<b>Not Applicable</b>
ORDER INFO			
MHT Example ^	L13.0-ZE560	120V - 277V	Not Applicable

Aesthetics & Options

TRIM	FINISH	COLOR TEMP	OPTIONS
<b>Not Applicable</b>	<b>AC</b> - Antique Copper <b>TB</b> - Textured Black <b>AS</b> - Antique Silver <b>BT</b> - Bronze Mist <b>BZ</b> - Textured Bronze <b>BN</b> - Brushed Nickel (Standard) <b>TW</b> - Textured White <b>SM</b> - Matte Silver <b>SN</b> - Sand <b>SW</b> - Swedish Steel	<b>30K</b> - 3000K Color Temp <b>35K</b> - 3500K Color Temp <b>40K</b> - 4000K Color Temp <b>50K</b> - 5000K Color Temp	<b>F</b> - Fused <b>WAL</b> - White Acrylic <b>WLL</b> - White Acrylic Formulated For LED Fixtures
ORDER INFO			
Not Applicable Example ^	AC	30K	F

PROD	SOURCE	30K SPECS			
MHT	L13.0	<ul style="list-style-type: none"> <li>80 CRI Typ.</li> <li>30K - 3000K Color Temp</li> <li>1700 LED Source Lumens</li> <li>130.8 LED Source Lumens Per Watt</li> </ul>			
	L16.3	<ul style="list-style-type: none"> <li>80 CRI Typ.</li> <li>30K - 3000K Color Temp</li> <li>2110 LED Source Lumens</li> <li>129.4 LED Source Lumens Per Watt</li> </ul>			
	21.0	<ul style="list-style-type: none"> <li>80 CRI Typ.</li> <li>30K - 3000K Color Temp</li> <li>2640 LED Source Lumens</li> <li>125.7 LED Source Lumens Per Watt</li> </ul>			

REPLACEMENT PART	PART NO	NOTES
White Acrylic Diffuser	3021460	
White Acrylic LED Diffuser	3053360	
		Don't see the configuration you are looking for? Call us today at (513) 858-6004



TERONLIGHTING.COM  
 33 DONALD DR, FAIRFIELD, OH 45014  
 P: 513.858.6004 F: 513.858.6038  
 E: SALES@TERONLIGHT.COM



We reserve the right to revise the design components of any product due to parts availability or change in UL standards, without assuming any obligation or liability to modify any products previously manufactured, and without notice.