

# BIRDIE CA EYE LED

Architectural Outdoor



PROJECT:	
TYPE:	
PO#:	QTY:
COMMENTS:	



## FEATURES

- Die-Cast Aluminum Housing w/ Matte White Polyester Powder Coat Finish
- Die-Cast Aluminum Grill (Standard) w/ Matte White Polyester Powder Coat Finish
- White Polycarbonate Lens
- Front and Back Gasketing
- Stainless Steel Housing Screws
- Mounts Directly to 4" Junction Box (By Others)
- CSA Listed Wet Location
- Emergency Battery Available (Damp Location Only) (Wall Mount Only)
- LED Light Fixture
- Mounting Hardware Included
- Vandal Resistant

## LINE DRAWING

LINE DRAWING NOT TO SCALE

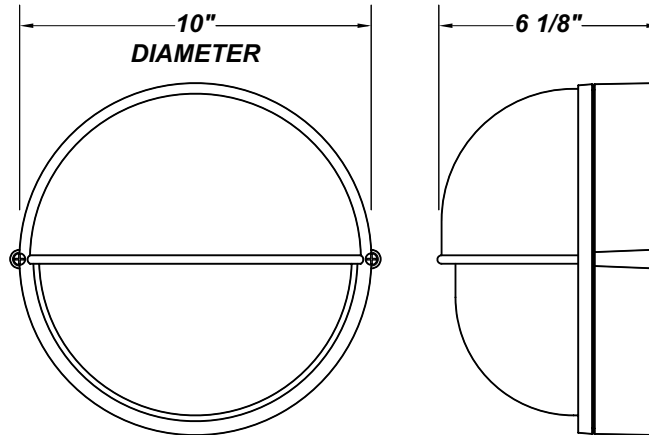

## FINISHES

Antique Copper



Antique Silver



Bronze Mist

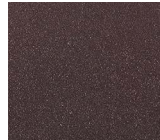

Matte Silver

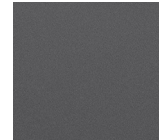

Sand

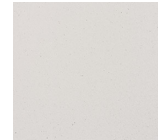

Swedish Steel

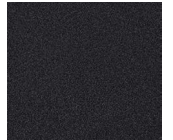

Textured Black

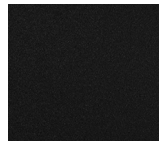

Textured Bronze



Textured White

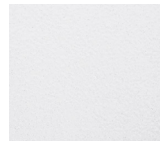

For RAL Colors & Custom Match - Contact Teron Lighting Inc.

# BIRDIE CA EYE LED

Architectural Outdoor



Fixture Core

PROJECT:	
TYPE:	
PO#:	QTY:
COMMENTS:	

PRODUCT CODE	SOURCE/WATTAGE	VOLTAGE	DIMMING DRIVER
BEC - Birdie CA	<b>L13.0-LE350</b> - 13W @ 350mA Phase Dimming Driver (Dimmable @ 120V Only) (Dimmable to 10%)  <b>L13.0-350</b> - 13W @ 350mA - 350mA Constant Current Driver	<b>120V</b> <b>277V</b> (50 / 60Hz)	Not Applicable
ORDER INFO			
BEC	L13.0-LE350	120V	Not Applicable

Example ^ (may not represent a manufacturable product)

Aesthetics & Options

TRIM	FINISH	COLOR TEMP	OPTIONS
EYE	<b>AC</b> - Antique Copper <b>AS</b> - Antique Silver <b>BT</b> - Bronze Mist <b>SM</b> - Matte Silver <b>SN</b> - Sand <b>SW</b> - Swedish Steel <b>TB</b> - Textured Black  <b>BZ</b> - Textured Bronze <b>TW</b> - Textured White <b>WH</b> - Matte White (Standard)	<b>30K</b> - 3000K Color Temp <b>35K</b> - 3500K Color Temp <b>40K</b> - 4000K Color Temp	<b>EB</b> - 5.0W Integral EM Battery (Wall Mount Only) <b>F</b> - Fused <b>PCL</b> - Photocell <b>SP</b> - Surge Protector <b>TP</b> - Tamper Resistant Screws
ORDER INFO			
EYE	AC	30K	EB

Example ^ (may not represent a manufacturable product)

PROD	SOURCE	30K SPECS			
BEC	L13.0	<ul style="list-style-type: none"> <li>30K - 3000K Color Temp</li> <li>1614 LED Source Lumens</li> <li>80.7 LED Source Lumens Per Watt</li> </ul>			

REPLACEMENT PART	PART NO	NOTES
Frosted Glass Lens	3700862	
Birdie CA EYE Fascia (Specify Finish)	5510199	

Don't see the configuration you are looking for?  
Call us today at (513) 858-6004



TERONLIGHTING.COM  
 33 DONALD DR, FAIRFIELD, OH 45014  
 P: 513.858.6004 F: 513.858.6038  
 E: SALES@TERONLIGHT.COM



We reserve the right to revise the design components of any product due to parts availability or change in UL standards, without assuming any obligation or liability to modify any products previously manufactured, and without notice.