

WELLINGTON LED 18"

Architectural Outdoor



PROJECT:	
TYPE:	
PO#:	QTY:
COMMENTS:	

FEATURES

- White Injection-Molded Polycarbonate Housing
- White Injection-Molded Lens
- ETL Listed Wet Location For Wall or Ceiling Mount



LINE DRAWING

LINE DRAWING NOT TO SCALE

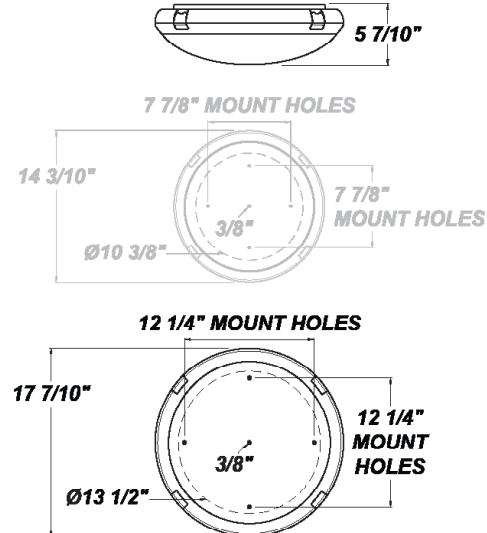

FINISHES

For RAL Colors
& Custom
Match -
Contact Teron
Lighting Inc.

WELLINGTON LED 18"

Architectural Outdoor



Fixture Core

PROJECT:	
TYPE:	
PO#:	QTY:
COMMENTS:	

PRODUCT CODE	SOURCE/WATTAGE	VOLTAGE	DIMMING DRIVER
WGN18 - Wellington 17.7"	L34.0 - 34.0W @ 2380mA	120-277V	Not Applicable
ORDER INFO			
WGN18	L34.0	120-277V	Not Applicable

Example ^ (may not represent a manufacturable product)

Aesthetics & Options

TRIM	FINISH	COLOR TEMP	OPTIONS
Not Applicable	WH - White	40K - 4000K Color Temp 50K - 5000K Color Temp	Not Applicable
ORDER INFO			
Not Applicable	WH	40K	Not Applicable

Example ^ (may not represent a manufacturable product)

PROD	SOURCE	40K SPECS	50K SPECS
WGN18	L34.0	<ul style="list-style-type: none"> • 40K - 4000K Color Temp • 2380 LED Source Lumens • 89.5 LED Source Lumens Per Watt • 2865 Delivered LED Lumens • 89.5 Delivered LED Lumens Per Watt 	<ul style="list-style-type: none"> • 50K - 5000K Color Temp • 2450 LED Source Lumens • 72.1 LED Source Lumens Per Watt

REPLACEMENT PART	PART NO	NOTES
Not Applicable	Not Applicable	

Don't see the configuration you are looking for?
Call us today at (513) 858-6004



TERONLIGHTING.COM
33 DONALD DR, FAIRFIELD, OH 45014
P: 513.858.6004 F: 513.858.6038
E: SALES@TERONLIGHT.COM



We reserve the right to revise the design components of any product due to parts availability or change in UL standards, without assuming any obligation or liability to modify any products previously manufactured, and without notice.