

ROYAL TTB LED

Architectural Outdoor



PROJECT:	
TYPE:	
PO#:	QTY:
COMMENTS:	



FEATURES

- Aluminum Reflector
- CSA Listed Wet Location
- LED Light Fixture
- Luminous White 75% DR Acrylic Diffuser
- Mounting Hardware Included
- Mounts Directly to 4" Junction Box (By Others)
- Steel Fascia w/ Textured Black Polyester Powder Coat Finish
- Steel Mounting Pan w/ Hi-Reflectance White Powder Coat Finish



LINE DRAWING

LINE DRAWING NOT TO SCALE

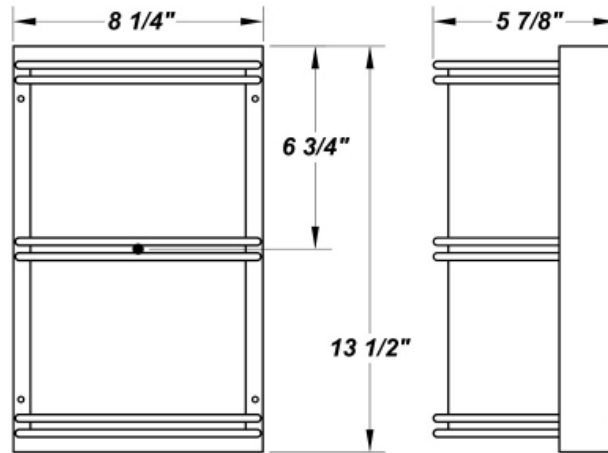

FINISHES

Antique Copper



Antique Silver

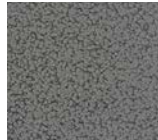

Bronze Mist



Matte Silver

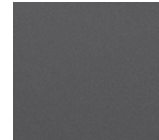

Sand

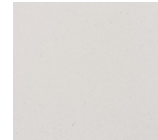

Swedish Steel

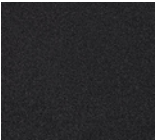

Textured Black

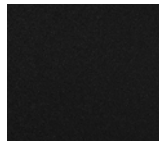

Textured Bronze

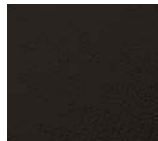

Textured White

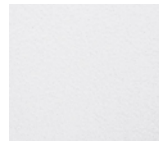

For RAL Colors & Custom Match - Contact Teron Lighting Inc.

ROYAL TTB LED

Architectural Outdoor



Fixture Core

PROJECT:	
TYPE:	
PO#:	QTY:
COMMENTS:	

PRODUCT CODE	SOURCE/WATTAGE	VOLTAGE	DIMMING DRIVER
RL - Royal	L15.0-TE600 - 15.0W @ 600mA ELV Dimming Driver L18.0-TE700 - 18.0W @ 700mA ELV Dimming Driver L18.0-ZE700 - 18.0W @ 700mA Line Voltage 4-Wire Dimming Driver (Dimmable 0 - 10V)	120V 277V (50 / 60Hz)	Not Applicable
ORDER INFO			
RL	L15.0-TE600	120V	Not Applicable

Example ^ (may not represent a manufacturable product)

Aesthetics & Options

TRIM	FINISH	COLOR TEMP	OPTIONS
TTB	AC - Antique Copper AS - Antique Silver BT - Bronze Mist SM - Matte Silver SN - Sand SW - Swedish Steel TB - Textured Black (Standard)	BZ - Textured Bronze TW - Textured White 30K - 3000K Color Temp 35K - 3500K Color Temp 40K - 4000K Color Temp	F - Fused TP - Tamper Resistant Screws
ORDER INFO			
TTB	AC	30K	F

Example ^ (may not represent a manufacturable product)

PROD	SOURCE				
RL	L15.0	<ul style="list-style-type: none"> 30K - 3000K Color Temp 2048 LED Source Lumens 136.5 LED Source Lumans Per Watt 			
	L18.0	<ul style="list-style-type: none"> 30K - 3000K Color Temp 2390 LED Source Lumens 132.8 LED Source Lumans Per Watt 			

REPLACEMENT PART	PART NO	NOTES
White 75% DR Acrylic Lens	3051060	Don't see the configuration you are looking for? Call us today at (513) 858-6004



TERONLIGHTING.COM
 33 DONALD DR, FAIRFIELD, OH 45014
 P: 513.858.6004 F: 513.858.6038
 E: SALES@TERONLIGHT.COM



We reserve the right to revise the design components of any product due to parts availability or change in UL standards, without assuming any obligation or liability to modify any products previously manufactured, and without notice.

ROYAL TTB LED

Architectural Outdoor



Fixture Core

PROJECT:	
TYPE:	
PO#:	QTY:
COMMENTS:	

PRODUCT CODE	SOURCE/WATTAGE	VOLTAGE	DIMMING DRIVER
RL - Royal	L30.0-ZE1050 - 30.0W @ 1050mA Line Voltage 4-Wire Dimming Driver (Dimmable 0 - 10V)	120V 277V (50 / 60Hz)	Not Applicable
ORDER INFO			
RL	L15.0-TE600	120V	Not Applicable

Example ^ (may not represent a manufacturable product)

Aesthetics & Options

TRIM	FINISH	COLOR TEMP	OPTIONS
TTB	AC - Antique Copper AS - Antique Silver BT - Bronze Mist SM - Matte Silver SN - Sand SW - Swedish Steel TB - Textured Black (Standard) BZ - Textured Bronze TW - Textured White	30K - 3000K Color Temp 35K - 3500K Color Temp 40K - 4000K Color Temp	F - Fused TP - Tamper Resistant Screws
ORDER INFO			
TTB	AC	30K	F

Example ^ (may not represent a manufacturable product)

PROD	SOURCE	30K SPECS			
RL	L30.0	<ul style="list-style-type: none"> 30K - 3000K Color Temp 3585 LED Source Lumens 119.5 LED Source Lumans Per Watt 			

REPLACEMENT PART	PART NO	NOTES
White 75% DR Acrylic Lens	3051060	

Don't see the configuration you are looking for?
Call us today at (513) 858-6004



TERONLIGHTING.COM
33 DONALD DR, FAIRFIELD, OH 45014
P: 513.858.6004 F: 513.858.6038
E: SALES@TERONLIGHT.COM



We reserve the right to revise the design components of any product due to parts availability or change in UL standards, without assuming any obligation or liability to modify any products previously manufactured, and without notice.