

ALLEGRO W PRF LED

Architectural Outdoor



PROJECT:	
TYPE:	
PO#:	QTY:
COMMENTS:	



FEATURES

- Aluminum Housing w/ Textured Black Polyester Powder Coat Finish
- Aluminum End Caps and Trim Bars w/ Textured Black Polyester Powder Coat Finish
- Aluminum Mount Pan w/ Hi-Reflectance White Powder Coat Finish
- Luminous White Acrylic Wrap-Around Diffuser
- Luminous White Acrylic Top and Bottom Lens Panels
- Mounts Over 4" Junction Box w/ Easy-hang Wall Mounting Plate (Included)
- Operating Temperature Range for EB (0° - 50°C)
- CSA Approved For Wet Location For Vertical Mounting
- LED Light Fixture
- Mounting Hardware Included

LINE DRAWING

LINE DRAWING NOT TO SCALE

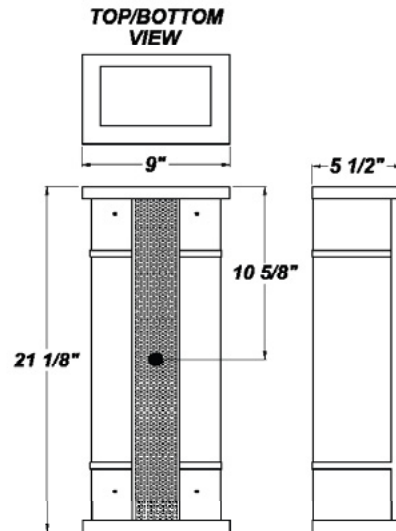

FINISHES

Antique Copper



Antique Silver

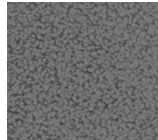

Bronze Mist

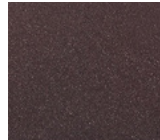

Matte Silver

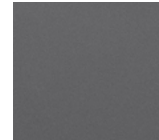

Metallic Black

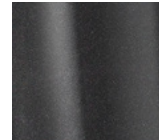

Sand

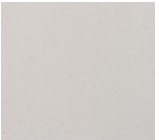

Swedish Steel

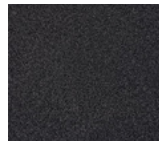

Textured Black

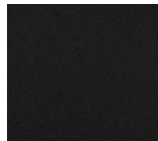

Textured Bronze

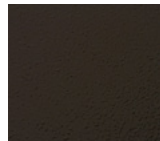

Textured White

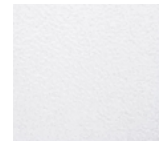

For RAL Colors & Custom Match - Contact Teron Lighting Inc.

ALLEGRO W PRF LED

Architectural Outdoor



Fixture Core

PROJECT:	
TYPE:	
PO#:	QTY:
COMMENTS:	

PRODUCT CODE	SOURCE/WATTAGE	VOLTAGE	DIMMING DRIVER
ALLW - Allegro W	L19.0-ZE700 - 30W @ 700mA 0-10V Dimming Driver L24.0-ZE875 - 33W @ 875mA 0-10V Dimming Driver L31.0-ZE1150 - 44W @ 1150mA 0-10V Dimming Driver	120V 277V (50 / 60Hz)	Not Applicable
ORDER INFO			
ALLW	L19.0-ZE700	120V	Not Applicable

Example ^ (may not represent a manufacturable product)

Aesthetics & Options

TRIM	FINISH	COLOR TEMP	OPTIONS
PRF	AC - Antique Copper TB - Textured Black (Standard) AS - Antique Silver BT - Bronze Mist BZ - Textured Bronze MB - Metallic Black SM - Matte Silver TW - Textured White SN - Sand SW - Swedish Steel	30K - 3000K Color Temp 35K - 3500K Color Temp 40K - 4000K Color Temp	F - Fused TP - Tamper Resistant Screws
ORDER INFO			
PRF	AC	30K	F

Example ^ (may not represent a manufacturable product)

PROD	SOURCE	30K SPECS			
ALLW	L19.0	<ul style="list-style-type: none"> 30K - 3000K Color Temp 2489 LED Source Lumens 113 LED Source Lumens Per Watt 			
	L24.0	<ul style="list-style-type: none"> 30K - 3000K Color Temp 3180 LED Source Lumens 106 LED Source Lumens Per Watt 			
	L31.0	<ul style="list-style-type: none"> 30K - 3000K Color Temp 4125 LED Source Lumens 106 LED Source Lumens Per Watt 			

REPLACEMENT PART	PART NO	NOTES
White Acrylic Lens Assembly	9801460	Operating Temperature Range for EB (0° - 50°C)
		Don't see the configuration you are looking for? Call us today at (513) 858-6004



TERONLIGHTING.COM
 33 DONALD DR, FAIRFIELD, OH 45014
 P: 513.858.6004 F: 513.858.6038
 E: SALES@TERONLIGHT.COM



We reserve the right to revise the design components of any product due to parts availability or change in UL standards, without assuming any obligation or liability to modify any products previously manufactured, and without notice.

ALLEGRO W PRF LED

Architectural Outdoor



Fixture Core

PROJECT:	
TYPE:	
PO#:	QTY:
COMMENTS:	

PRODUCT CODE	SOURCE/WATTAGE	VOLTAGE	DIMMING DRIVER
ALLW - Allegro W	L38.0-ZE1400 - 50W @ 1400mA 0-10V Dimming Driver L38.0-TE1400 - 60W @ 1400mA ELV Dimming Driver L36.0-ZE1100 - 36W @ 1100mA 0-10V Dimming Driver	120V 277V (50 / 60Hz)	Not Applicable
ORDER INFO			
ALLW	L38.0-ZE1400	120V	Not Applicable

Example ^ (may not represent a manufacturable product)

Aesthetics & Options

TRIM	FINISH	COLOR TEMP	OPTIONS
Not Applicable	AC - Antique Copper TB - Textured Black (Standard) AS - Antique Silver BT - Bronze Mist BZ - Textured Bronze MB - Metallic Black SM - Matte Silver TW - Textured White SN - Sand SW - Swedish Steel	30K - 3000K Color Temp 35K - 3500K Color Temp 40K - 4000K Color Temp	EB - Emergency Battery (L36.0 Only) F - Fused TP - Tamper Resistant Screws
ORDER INFO			
Not Applicable	AC	30K	EB

Example ^ (may not represent a manufacturable product)

PROD	SOURCE	30K SPECS			
ALLW	L36.0	<ul style="list-style-type: none"> 30K - 3000K Color Temp 5465 LED Source Lumens 151.8 LED Source Lumens per Watt 			
	L38.3	<ul style="list-style-type: none"> 30K - 3000K Color Temp 5208 LED Source Lumens 109 LED Source Lumens Per Watt 			

REPLACEMENT PART	PART NO	NOTES
White Acrylic Lens Assembly	9801460	Operating Temperature Range for EB (0° - 50°C)
		Don't see the configuration you are looking for? Call us today at (513) 858-6004



TERONLIGHTING.COM
 33 DONALD DR, FAIRFIELD, OH 45014
 P: 513.858.6004 F: 513.858.6038
 E: SALES@TERONLIGHT.COM



We reserve the right to revise the design components of any product due to parts availability or change in UL standards, without assuming any obligation or liability to modify any products previously manufactured, and without notice.