

MYRTLE BEACH II LED

Architectural Indoor



PROJECT:	
TYPE:	
PO#:	QTY:
COMMENTS:	

FEATURES

- Aluminum Mounting Pan and Stems w/ Matte Silver Powder Coat Finish
- CSA Listed Damp Location
- LED Light Fixture
- Luminous White Acrylic Diffuser
- Mounting Hardware Included
- Mounts Directly to 4" Junction Box (By Others)

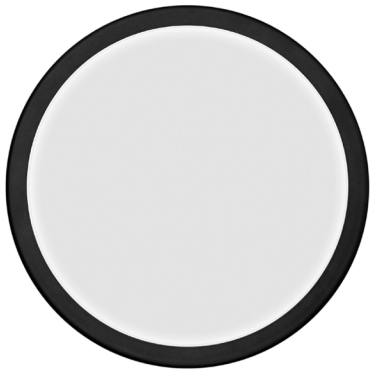
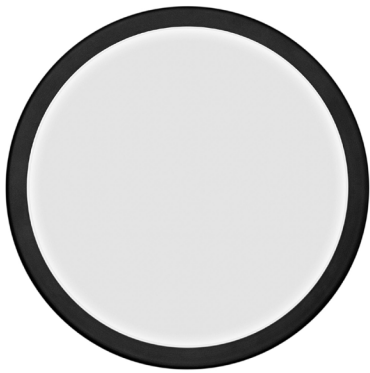

LINE DRAWING

LINE DRAWING NOT TO SCALE

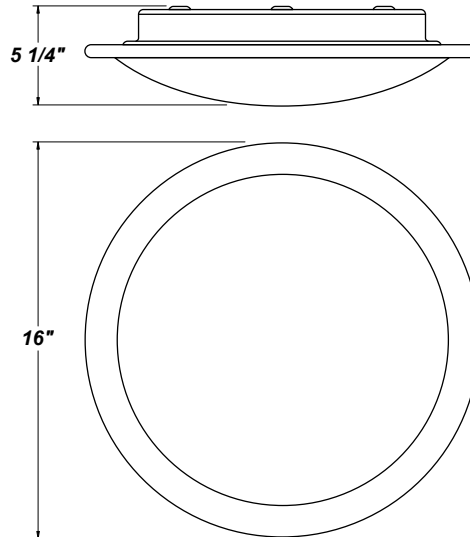

FINISHES

Antique Copper

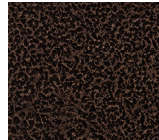

Antique Silver

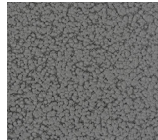

Bronze Mist



Matte Silver

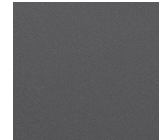

Sand

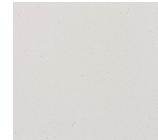

Swedish Steel

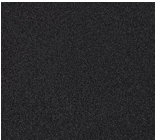

Textured Black

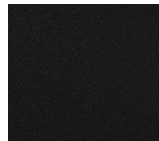

Textured Bronze

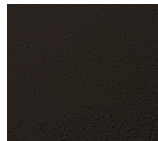

Textured White

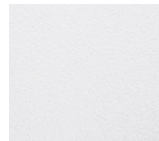

For RAL Colors & Custom Match - Contact Teron Lighting Inc.

MYRTLE BEACH II LED

Architectural Indoor



Fixture Core

PROJECT:	
TYPE:	
PO#:	QTY:
COMMENTS:	

PRODUCT CODE	SOURCE/WATTAGE	VOLTAGE	DIMMING DRIVER
MHT - Myrtle Beach II	L13.0-ZE560 - (48) LED Array @ Line Voltage 4-Wire Dimming Driver (Dimmable 0 - 10V) L16.3-ZE560 - (60) LED Array @ Line Voltage 4-Wire Dimming Driver (Dimmable 0 - 10V) L21.0-ZE700 - (60) LED Array @ Line Voltage 4-Wire Dimming Driver (Dimmable 0 - 10V)	120V - 277V (50 / 60Hz)	Not Applicable
ORDER INFO			
MHT Example ^	L13.0-ZE560	120V - 277V	Not Applicable

Aesthetics & Options

TRIM	FINISH	COLOR TEMP	OPTIONS
Not Applicable	AC - Antique Copper TB - Textured Black AS - Antique Silver BT - Bronze Mist BZ - Textured Bronze BN - Brushed Nickel (Standard) TW - Textured White SM - Matte Silver SN - Sand SW - Swedish Steel	30K - 3000K Color Temp 35K - 3500K Color Temp 40K - 4000K Color Temp	F - Fused WAL - White Acrylic WLL - White Acrylic Formulated For LED Fixtures
ORDER INFO			
Not Applicable Example ^	AC	30K	F

PROD	SOURCE	30K SPECS			
MHT	L13.0	<ul style="list-style-type: none"> 80 CRI Typ. 30K - 3000K Color Temp 1700 LED Source Lumens 130.8 LED Source Lumens Per Watt 			
	L16.3	<ul style="list-style-type: none"> 80 CRI Typ. 30K - 3000K Color Temp 2110 LED Source Lumens 129.4 LED Source Lumens Per Watt 			
	21.0	<ul style="list-style-type: none"> 80 CRI Typ. 30K - 3000K Color Temp 2640 LED Source Lumens 125.7 LED Source Lumens Per Watt 			

REPLACEMENT PART	PART NO	NOTES
White Acrylic Diffuser	3021460	
White Acrylic LED Diffuser	3053360	
		Don't see the configuration you are looking for? Call us today at (513) 858-6004



TERONLIGHTING.COM
 33 DONALD DR, FAIRFIELD, OH 45014
 P: 513.858.6004 F: 513.858.6038
 E: SALES@TERONLIGHT.COM



We reserve the right to revise the design components of any product due to parts availability or change in UL standards, without assuming any obligation or liability to modify any products previously manufactured, and without notice.