

# MEDALLION C LED

Architectural Indoor



PROJECT:	
TYPE:	
PO#:	QTY:
COMMENTS:	

## FEATURES

- Steel Trim w/ Brushed Nickel Plated Finish
- Twist-Lock White Glass Diffuser
- Steel Mounting Pan w/ Hi-Reflectance White Powder Coat Finish
- Mounts Directly to 4" Junction Box (By Others) J-Box Centered in Fixture
- L21.0W Estimated Lumen Depreciation (TM-21) 72.92% of Initial Lumens (L70) @ 100,000 hours
- CSA Listed Damp Location
- LED Light Fixture
- Mounting Hardware Included



## LINE DRAWING

LINE DRAWING NOT TO SCALE

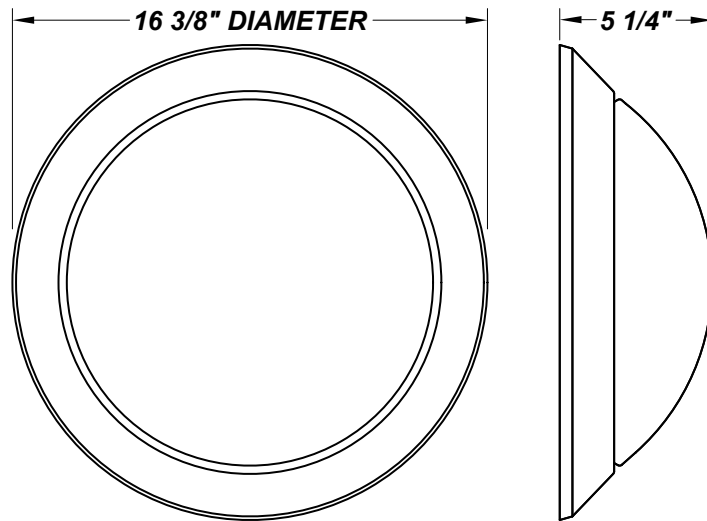

## FINISHES

Antique Copper



Antique Silver

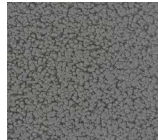

Bronze Mist



Matte Silver

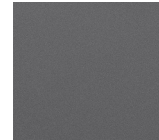

Metallic Black

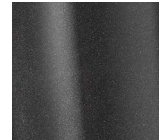

Sand

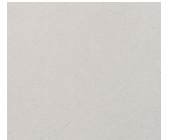

Swedish Steel



Textured Black

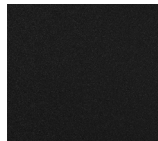

Textured Bronze



Textured White

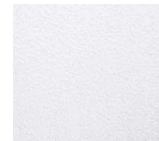

For RAL Colors & Custom Match - Contact Teron Lighting Inc.

# MEDALLION C LED

Architectural Indoor



Fixture Core

PROJECT:	
TYPE:	
PO#:	QTY:
COMMENTS:	

PRODUCT CODE	SOURCE/WATTAGE	VOLTAGE	DIMMING DRIVER
<b>MEDC - Medallion C</b>	<b>L13.0-ZE560</b> - (48) LED Array @ Line Voltage 4-Wire Dimming Driver (Dimmable 0 - 10V) <b>L16.3-ZE560</b> - (60) LED Array @ Line Voltage 4-Wire Dimming Driver (Dimmable 0 - 10V) <b>L21.0-ZE700</b> - (60) LED Array @ Line Voltage 4-Wire Dimming Driver (Dimmable 0 - 10V)	<b>120V - 277V</b> (50 / 60Hz)	<b>Not Applicable</b>
ORDER INFO			
MEDC Example ^	L13.0-ZE560	120V - 277V	Not Applicable

Aesthetics & Options

TRIM	FINISH	COLOR TEMP	OPTIONS
<b>Not Applicable</b>	<b>AC</b> - Antique Copper <b>SW</b> - Swedish Steel <b>AS</b> - Antique Silver <b>BT</b> - Bronze Mist <b>TB</b> - Textured Black <b>BN</b> - Brushed Nickel (Standard) <b>BZ</b> - Textured Bronze <b>SM</b> - Matte Silver <b>TW</b> - Textured White <b>MB</b> - Metallic Black <b>SN</b> - Sand	<b>27K</b> - 2700K Color Temp <b>30K</b> - 3000K Color Temp <b>35K</b> - 3500K Color Temp <b>40K</b> - 4000K Color Temp	<b>F</b> - Fused <b>MSI</b> - MSI-FM105 120/277V
ORDER INFO			
Not Applicable Example ^	AC	27K	F

PROD	SOURCE	30K SPECS			
<b>MEDC</b>	L13.0	<ul style="list-style-type: none"> <li>80 CRI Typ.</li> <li>30K - 3000K Color Temp</li> <li>1700 LED Source Lumens</li> <li>130.8 LED Source Lumens Per Watt</li> </ul>			
	L16.3	<ul style="list-style-type: none"> <li>80 CRI Typ.</li> <li>30K - 3000K Color Temp</li> <li>2110 LED Source Lumens</li> <li>129.4 LED Source Lumens Per Watt</li> </ul>			
	L21.0	<ul style="list-style-type: none"> <li>80 CRI Typ.</li> <li>30K - 3000K Color Temp</li> <li>2640 LED Source Lumens</li> <li>125.7 LED Source Lumens Per Watt</li> </ul>			

REPLACEMENT PART	PART NO	NOTES
White Glass Diffuser	3701360	

Don't see the configuration you are looking for?  
Call us today at (513) 858-6004



TERONLIGHTING.COM  
 33 DONALD DR, FAIRFIELD, OH 45014  
 P: 513.858.6004 F: 513.858.6038  
 E: SALES@TERONLIGHT.COM



We reserve the right to revise the design components of any product due to parts availability or change in UL standards, without assuming any obligation or liability to modify any products previously manufactured, and without notice.