

BUNKER LED

Architectural Outdoor



PROJECT:	
TYPE:	
PO#:	QTY:
COMMENTS:	



FEATURES

- 120V Drivers Are Dimmable
- 277V Drivers Are Not Dimmable
- 347V Available L31.0
- Clear Prismatic UV-Stabilized Polycarbonate Ribbed Lens
- CSA Listed Wet Location Wall or Ceiling Mount
- Die-Cast Aluminum Ballast Housing w/ Textured Bronze Powder Coat Finish
- Emergency Battery Available (120 or 277 Only)
- Fully Silicone Gasketed Channel
- LED Light Fixture
- Mounts Direct to Flat Surface w/ Four #8 Wall Anchors (Not Included)
- Vandal Resistant

LINE DRAWING

LINE DRAWING NOT TO SCALE

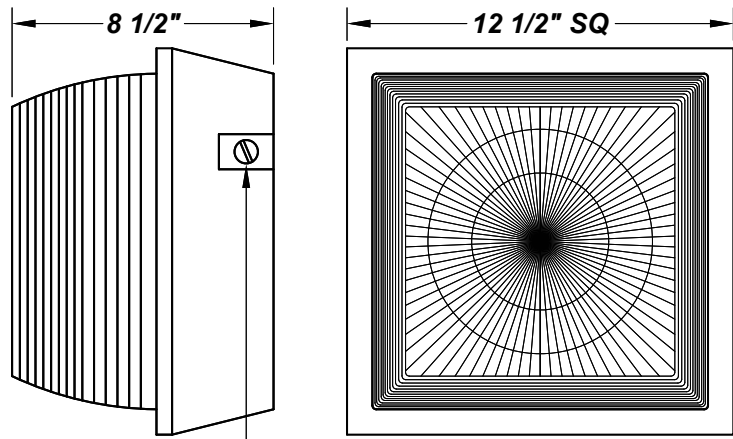

**THREE 0.50" CONDUIT ENTRY POINTS ON SIDES
ONE 0.50" CONDUIT ENTRY POINT ON BACK**

FINISHES

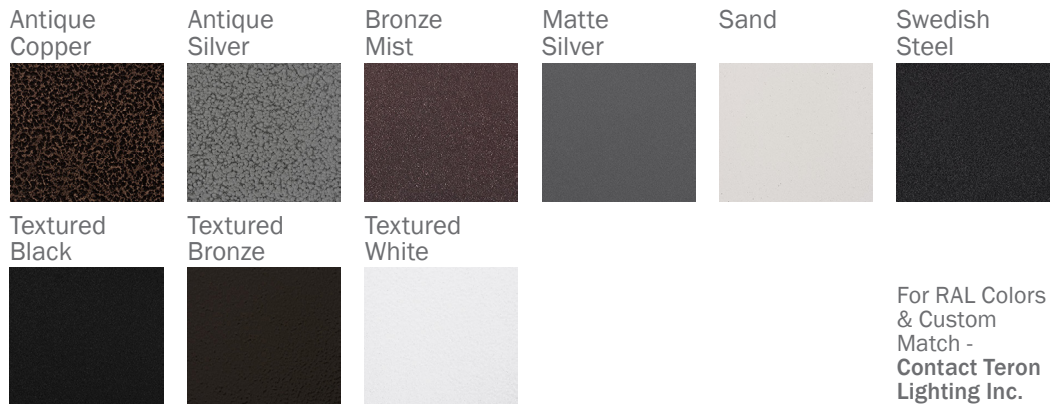

For RAL Colors & Custom Match - Contact Teron Lighting Inc.

BUNKER LED

Architectural Outdoor



Fixture Core

PROJECT:	
TYPE:	
PO#:	QTY:
COMMENTS:	

PRODUCT CODE	SOURCE/WATTAGE	VOLTAGE	DIMMING DRIVER
BK - Bunker	L31.0 - ZE740-31.0W @ 740mA Constant Current Driver	347V (31 Watt Only)	0-10V
ORDER INFO			
PN12	L31.0	347V	0-10V

Example ^ (may not represent a manufacturable product)

Aesthetics & Options

TRIM	FINISH	COLOR TEMP	OPTIONS
Not Applicable	AC - Antique Copper AS - Antique Silver BT - Bronze Mist SM - Matte Silver SN - Sand SW - Swedish Steel TB - Textured Black BZ - Textured Bronze (Standard) TW - Textured White	30K - 3000K Color Temp 35K - 3500K Color Temp 40K - 4000K Color Temp	TP - Tamper Resistant Screws WGD - Steel Wire Guard
ORDER INFO			
EFG HIJ	AC	30K	TP

Example ^ (may not represent a manufacturable product)

PROD	SOURCE	30K SPECS			
BK	L31.0	<ul style="list-style-type: none"> 30K - 3000K Color Temp 3642 LED Source Lumens 117.8 LED Source Lumens Per Watt 			

REPLACEMENT PART	PART NO	NOTES
Clear Polycarbonate Lens	34195	

Don't see the configuration you are looking for?
Call us today at (513) 858-6004



TERONLIGHTING.COM
 33 DONALD DR, FAIRFIELD, OH 45014
 P: 513.858.6004 F: 513.858.6038
 E: SALES@TERONLIGHT.COM



We reserve the right to revise the design components of any product due to parts availability or change in UL standards, without assuming any obligation or liability to modify any products previously manufactured, and without notice.

BUNKER LED

Architectural Outdoor



Fixture Core

PROJECT:	
TYPE:	
PO#:	QTY:
COMMENTS:	

PRODUCT CODE	SOURCE/WATTAGE	VOLTAGE	DIMMING DRIVER
BK - Bunker	L44.0 - 44.0W @ 350mA Constant Current Driver L40.0 - 40.0W @ 1100mA Constant Current Driver L24.0 - 24.0W @ 1050mA Constant Current Driver	100V 277V (50 / 60Hz)	Not Applicable
ORDER INFO			
PN12	L36.5	100V	SD50

Example ^ (may not represent a manufacturable product)

Aesthetics & Options

TRIM	FINISH	COLOR TEMP	OPTIONS
Not Applicable	AC - Antique Copper AS - Antique Silver BT - Bronze Mist SM - Matte Silver SN - Sand SW - Swedish Steel TB - Textured Black BZ - Textured Bronze (Standard) TW - Textured White	30K - 3000K Color Temp 35K - 3500K Color Temp 40K - 4000K Color Temp	EB - 5W Integral EM Battery F - Fused PCL - Photocell TP - Tamper Resistant Screws WGD - Steel Wire Guard
ORDER INFO			
EFG HIJ	AC	35K	99K - WUV - XYZ

Example ^ (may not represent a manufacturable product)

PROD	SOURCE	30K SPECS			
BK	L44.0	<ul style="list-style-type: none"> 30K - 3000K Color Temp 3766 LED Source Lumens 85.6 LED Source Lumens Per Watt 	<ul style="list-style-type: none"> 30K - 3000K Color Temp 3766 LED Source Lumens 85.6 LED Source Lumens Per Watt 		
	L40.0	<ul style="list-style-type: none"> 30K - 3000K Color Temp 3418 LED Source Lumens 85.5 LED Source Lumens Per Watt 	<ul style="list-style-type: none"> 30K - 3000K Color Temp, 3418 LED Source Lumens 85.5 LED Source Lumens Per Watt 		
	L24.0	<ul style="list-style-type: none"> 30K - 3000K Color Temp 3263 LED Source Lumens 135 LED Source Lumens Per Watt 	<ul style="list-style-type: none"> 30K - 3000K Color Temp, 3263 LED Source Lumens 135 LED Source Lumens Per Watt 		

REPLACEMENT PART	PART NO	NOTES
Clear Polycarbonate Lens	34195	
		Don't see the configuration you are looking for? Call us today at (513) 858-6004



TERONLIGHTING.COM
33 DONALD DR, FAIRFIELD, OH 45014
P: 513.858.6004 F: 513.858.6038
E: SALES@TERONLIGHT.COM



We reserve the right to revise the design components of any product due to parts availability or change in UL standards, without assuming any obligation or liability to modify any products previously manufactured, and without notice.