

BEL-AIR LED

Architectural Indoor



PROJECT:	
TYPE:	
PO#:	QTY:
COMMENTS:	

FEATURES

- Frosted White Acrylic Diffuser
- Steel Mounting Pan w/ Matte Silver Powder Coat Finish
- Aluminum Reflective LED Mount Plate
- Steel Trim w/ Matte Silver Powder Coat Finish
- Open Top, Mounts Directly to 4" Junction Box (By Others)
- ADA Compliant
- CSA Listed Dry Location For Wall Mounting
- LED Light Fixture
- Mounting Hardware Included
- Vandal Resistant

LINE DRAWING

LINE DRAWING NOT TO SCALE

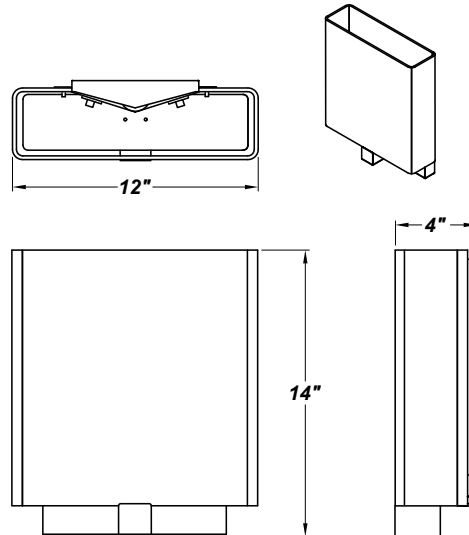

FINISHES

Antique Copper

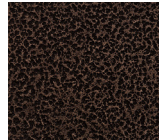

Antique Silver

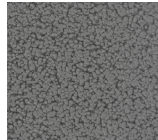

Bronze Mist



Matte Silver

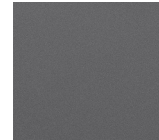

Metallic Black

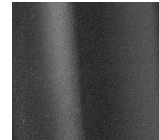

Sand



Swedish Steel



Textured Black

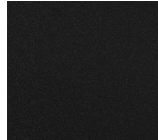

Textured Bronze



Textured White

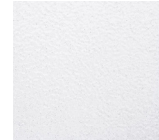

For RAL Colors & Custom Match - Contact Teron Lighting Inc.

BEL-AIR LED

Architectural Indoor



Fixture Core

PROJECT:	
TYPE:	
PO#:	QTY:
COMMENTS:	

PRODUCT CODE	SOURCE/WATTAGE	VOLTAGE	DIMMING DRIVER
BLR - Bel-Air	L50.0-ZE1400 - 50W @ 1400mA 0-10V Dimming Driver	120 - 277V	Not Applicable
ORDER INFO			
BLR Example ^	L50.0-ZE1500	120-277V	Not Applicable

Aesthetics & Options

TRIM	FINISH	COLOR TEMP	OPTIONS
Not Applicable	AC - Antique Copper AS - Antique Silver BT - Bronze Mist MB - Metallic Black SM - Matte Silver (Standard) SN - Sand SW - Swedish Steel TB - Textured Black BZ - Textured Bronze TW - Textured White	27K - 2700K Color Temp 30K - 3000K Color Temp 35K - 3500K Color Temp 40K - 4000K Color Temp	F - Fused TCV - White Acrylic Top Cover TP - Tamper Resistant Screws WAL - White Acrylic Lens
ORDER INFO			
Not Applicable Example ^	AC	27K	F

PROD	SOURCE	30K SPECS			
BLR	L50.0	<ul style="list-style-type: none"> 30K - 3000K Color Temp 5505.3 LED Source Lumens 117.1 LED Source Lumens Per Watt 			

REPLACEMENT PART	PART NO	NOTES
White Acrylic Lens	3040560	

Don't see the configuration you are looking for?
Call us today at (513) 858-6004



TERONLIGHTING.COM
 33 DONALD DR, FAIRFIELD, OH 45014
 P: 513.858.6004 F: 513.858.6038
 E: SALES@TERONLIGHT.COM



We reserve the right to revise the design components of any product due to parts availability or change in UL standards, without assuming any obligation or liability to modify any products previously manufactured, and without notice.