

# GUARDIAN W VHT LED 16"

Architectural Outdoor

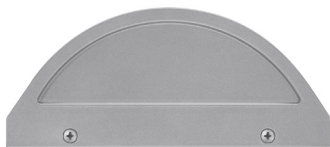

PROJECT:	
TYPE:	
PO#:	QTY:
COMMENTS:	



## FEATURES

- Extruded Aluminum Housing w/ Matte Silver Polyester Powder Coat Finish
- Aluminum Fascia w/ Matte Silver Polyester Powder Coat Finish
- Die Cast Aluminum End Caps w/ Matte Silver Polyester Powder Coat Finish
- High Impact White Acrylic Diffuser (50% DR Acrylic)
- Aluminum Reflector w/ Hi-Reflectance White Powder Coat Finish
- Recessed Steel Screws
- Fixture Mounts Directly to Surface w/ Two Wall Anchors (Not Included)
- Over-Voltage, Over-Current, and Short-Circuit Protection w/ Auto Recovery
- 120V - 277V, Plus 347V For Selected Wattages
- Surge Protector
- ADA Compliant
- CSA Listed Wet Location
- LED Light Fixture
- Vandal Resistant

## LINE DRAWING

LINE DRAWING NOT TO SCALE

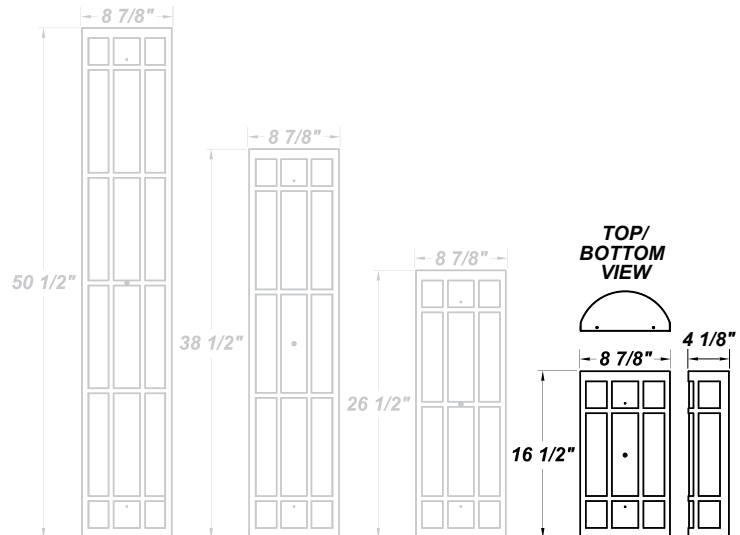

## FINISHES

Antique Copper

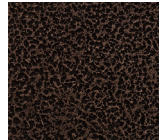

Antique Silver

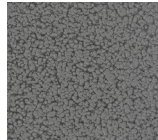

Bronze Mist



Matte Silver

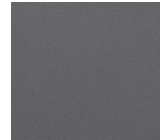

Metallic Black

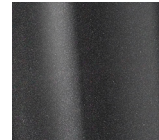

Sand

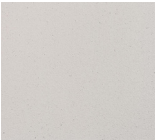

Swedish Steel

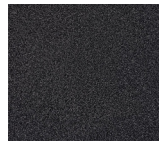

Textured Black

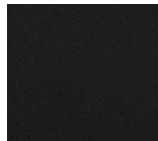

Textured Bronze

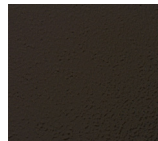

Textured White

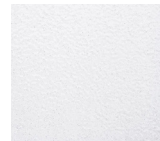

For RAL Colors & Custom Match - Contact Teron Lighting Inc.

# GUARDIAN W VHT LED 16"

Architectural Outdoor



Fixture Core

PROJECT:	
TYPE:	
PO#:	QTY:
COMMENTS:	

PRODUCT CODE	SOURCE/WATTAGE	VOLTAGE	DIMMING DRIVER
<b>GRDW16</b> - Guardian W 16"	<b>L12.0-TE350</b> - 12W @ 350mA ELV Dimming Driver  <b>L12.0-ZE350</b> - 12W @ Line Voltage 4-Wire Dimming Driver (Dimmable 0 - 10V)  <b>L18.0-TE500</b> - 18W @ 500mA ELV Dimming Driver	<b>120 - 277V</b>	<b>Not Applicable</b>
ORDER INFO			
GRDW16	L12.0-TE350	120 - 277V	Not Applicable

Example ^ (may not represent a manufacturable product)

Aesthetics & Options

TRIM	FINISH	COLOR TEMP	OPTIONS
<b>VHT</b>	<b>AC</b> - Antique Copper <b>TB</b> - Textured Black <b>AS</b> - Antique Silver <b>BT</b> - Bronze Mist <b>BZ</b> - Textured Bronze <b>MB</b> - Metallic Black <b>TW</b> - Textured White <b>SM</b> - Matte Silver (Standard) <b>SN</b> - Sand <b>SW</b> - Swedish Steel	<b>27K</b> - 2700K Color Temp <b>30K</b> - 3000K Color Temp <b>35K</b> - 3500K Color Temp <b>40K</b> - 4000K Color Temp <b>50K</b> - 5000K Color Temp	<b>OEL</b> - Single End Window <b>TEL</b> - Twin End Windows (Both Ends)
ORDER INFO			
VHT	AC	27K	OEL

Example ^ (may not represent a manufacturable product)

PROD	SOURCE	30K SPECS			
<b>GRDW</b>	L12.0	<ul style="list-style-type: none"> <li>80 CRI Typ.</li> <li>30K - 3000K Color Temp</li> <li>1739 LED Source Lumens</li> <li>144.9 LED Source Lumens Per Watt</li> </ul>			
	L18.0	<ul style="list-style-type: none"> <li>80 CRI Typ.</li> <li>30K - 3000K Color Temp</li> <li>2711 LED Source Lumens</li> <li>150.6 LED Source Lumens Per Watt</li> </ul>			

REPLACEMENT PART	PART NO	NOTES
16" Acrylic LED Lens Assembly	38200	(L18.0 is Dimmable From 120 - 230V)

Don't see the configuration you are looking for?  
Call us today at (513) 858-6004



TERONLIGHTING.COM  
33 DONALD DR, FAIRFIELD, OH 45014  
P: 513.858.6004 F: 513.858.6038  
E: SALES@TERONLIGHT.COM



We reserve the right to revise the design components of any product due to parts availability or change in UL standards, without assuming any obligation or liability to modify any products previously manufactured, and without notice.

# GUARDIAN W VHT LED 16"

Architectural Outdoor



Fixture Core

PROJECT:	
TYPE:	
PO#:	QTY:
COMMENTS:	

PRODUCT CODE	SOURCE/WATTAGE	VOLTAGE	DIMMING DRIVER
<b>GRDW16</b> - Guardian W 16"	<b>L18.0-LE500</b> - 18W @ 500mA 2-Wire Dimming Driver (120V Only) <b>L18.0-ZE500</b> - 18W @ Line Voltage 4-Wire Dimming Driver (Dimmable 0 - 10V) <b>L24.5-12CV</b> - 12V Constant Voltage Non-Dimming Electronic Driver	<b>120 - 277V</b>	<b>Not Applicable</b>
ORDER INFO			
GRDW16	L18.0-LE500	120 - 277V	Not Applicable

Example ^ (may not represent a manufacturable product)

Aesthetics & Options

TRIM	FINISH	COLOR TEMP	OPTIONS
<b>VHT</b>	<b>AC</b> - Antique Copper <b>TB</b> - Textured Black <b>AS</b> - Antique Silver <b>BT</b> - Bronze Mist <b>BZ</b> - Textured Bronze <b>MB</b> - Metallic Black <b>TW</b> - Textured White <b>SM</b> - Matte Silver (Standard) <b>SN</b> - Sand <b>SW</b> - Swedish Steel	<b>27K</b> - 2700K Color Temp <b>30K</b> - 3000K Color Temp <b>35K</b> - 3500K Color Temp <b>40K</b> - 4000K Color Temp <b>50K</b> - 5000K Color Temp	<b>OEL</b> - Single End Window <b>TEL</b> - Twin End Windows (Both Ends)
ORDER INFO			
VHT	AC	27K	OEL

Example ^ (may not represent a manufacturable product)

PROD	SOURCE	30K SPECS				
<b>GRDW</b>	L18.0	<ul style="list-style-type: none"> <li>80 CRI Typ.</li> <li>30K - 3000K Color Temp</li> <li>2711 LED Source Lumens</li> <li>150.6 LED Source Lumens Per Watt</li> </ul>				
	L24.5	<ul style="list-style-type: none"> <li>80 CRI Typ.</li> <li>30K - 3000K Color Temp</li> <li>9 LEDs Per ThermAdjust Module</li> <li>2528 LED Source Lumens</li> <li>103.2 LED Source Lumens Per Watt</li> </ul>				

REPLACEMENT PART	PART NO	NOTES
16" Acrylic LED Lens Assembly	38200	(L18.0 is Dimmable From 120 - 230V)

Don't see the configuration you are looking for?  
Call us today at (513) 858-6004



TERONLIGHTING.COM  
 33 DONALD DR, FAIRFIELD, OH 45014  
 P: 513.858.6004 F: 513.858.6038  
 E: SALES@TERONLIGHT.COM



We reserve the right to revise the design components of any product due to parts availability or change in UL standards, without assuming any obligation or liability to modify any products previously manufactured, and without notice.