

GUARDIAN W TBT LED 38"

Architectural Outdoor



PROJECT:	
TYPE:	
PO#:	QTY:
COMMENTS:	



FEATURES

- ADA Compliant
- Aluminum Fascia w/ Matte Silver Polyester Powder Coat Finish
- Aluminum Reflector w/ Hi-Reflectance White Powder Coat Finish
- CSA Listed Wet Location
- Die Cast Aluminum End Caps w/ Matte Silver Polyester Powder Coat Finish
- Emergency Battery Available
- Extruded Aluminum Housing w/ Matte Silver Polyester Powder Coat Finish
- Fixture Mounts Directly to Surface w/ Two Wall Anchors (Not Included)
- High Impact White Acrylic Diffuser (50% DR Acrylic)
- LED Light Fixture
- Recessed Steel Screws
- Surge Protector
- Vandal Resistant
- 120V - 277V

LINE DRAWING

LINE DRAWING NOT TO SCALE

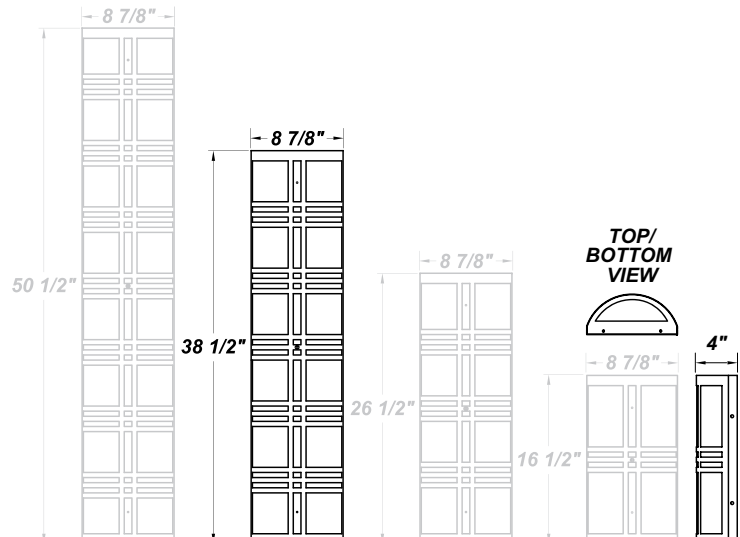

FINISHES

Antique Copper



Antique Silver



Bronze Mist



Matte Silver

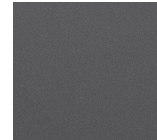

Sand

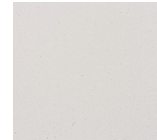

Swedish Steel

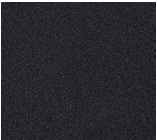

Textured Black

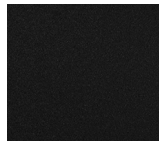

Textured Bronze

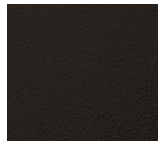

Textured White

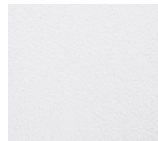

For RAL Colors & Custom Match - Contact Teron Lighting Inc.

GUARDIAN W TBT LED 38"

Architectural Outdoor



Fixture Core

PROJECT:	
TYPE:	
PO#:	QTY:
COMMENTS:	

PRODUCT CODE	SOURCE/WATTAGE	VOLTAGE	DIMMING DRIVER
GRDW36 - Guardian W 38"	L36.5-ZE1050 - 36.5W @ Line Voltage 4-Wire Dimming Driver (Dimmable 0 - 10V) L72.0-ZE714 - (700mA and 1400mA) 72.0W @ Line Voltage 4-Wire Dimming Driver (Dimmable 0 - 10V)	120 - 277V 347V Available For L36.5 Only	Not Applicable
ORDER INFO			
GRDW36	L36.5-ZE1050	120 - 277V	Not Applicable

Example ^ (may not represent a manufacturable product)

Aesthetics & Options

TRIM	FINISH	COLOR TEMP	OPTIONS
TBT	AC - Antique Copper TB - Textured Black AS - Antique Silver BT - Bronze Mist BZ - Textured Bronze SM - Matte Silver (Standard) TW - Textured White SN - Sand SW - Swedish Steel	30K - 3000K Color Temp 35K - 3500K Color Temp 40K - 4000K Color Temp 50K - 5000K Color Temp	OEL - Single End Window TEL - Twin End Windows (Both Ends) EB10 - Iota ILB-CP10-B Integral 10W LED Driver MSI - Steinel HFLUM2-WR Internal Motion Sensor
ORDER INFO			
TBT	AC	30K	OEL

Example ^ (may not represent a manufacturable product)

PROD	SOURCE	30K SPECS				
GRDW36	L36.5	<ul style="list-style-type: none"> 80 CRI Typ. 30K - 3000K Color Temp 5993 LED Source Lumens 156 LED Source Lumens Per Watt 				
	L72.0	<ul style="list-style-type: none"> 80 CRI Typ. 30K - 3000K Color Temp 10437 LED Source Lumens 145 LED Source Lumens Per Watt 				

REPLACEMENT PART	PART NO	NOTES
3' Acrylic LED Lens Assembly	38217	

Don't see the configuration you are looking for?
Call us today at (513) 858-6004



TERONLIGHTING.COM
 33 DONALD DR, FAIRFIELD, OH 45014
 P: 513.858.6004 F: 513.858.6038
 E: SALES@TERONLIGHT.COM



We reserve the right to revise the design components of any product due to parts availability or change in UL standards, without assuming any obligation or liability to modify any products previously manufactured, and without notice.