

GUARDIAN W CNL LED 50"

Architectural Outdoor



PROJECT:	
TYPE:	
PO#:	QTY:
COMMENTS:	

FEATURES

- 120V - 277V, Plus 347V For Selected Wattages
- Aluminum Fascia w/ Matte Silver Polyester Powder Coat Finish
- Aluminum Reflector w/ Hi-Reflectance White Powder Coat Finish
- CSA Listed Wet Location
- Die Cast Aluminum End Caps w/ Matte Silver Polyester Powder Coat Finish
- Emergency Battery Available
- Extruded Aluminum Housing w/ Matte Silver Polyester Powder Coat Finish
- Fixture Mounts Directly to Surface w/ Two Wall Anchors (Not Included)
- High Impact White Acrylic Diffuser (50% DR Acrylic)
- LED Light Fixture
- Over-Voltage, Over-Current, and Short-Circuit Protection w/ Auto Recovery
- Recessed Steel Screws
- Surge Protector
- Vandal Resistant



LINE DRAWING

LINE DRAWING NOT TO SCALE

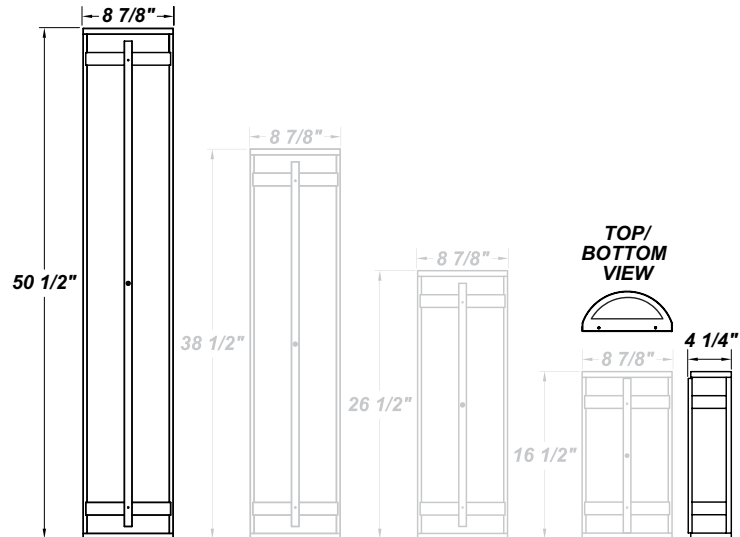

FINISHES

Antique Copper



Textured Black

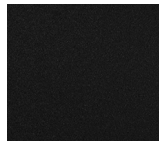

Antique Silver



Textured Bronze

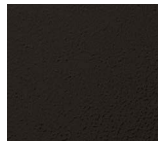

Bronze Mist

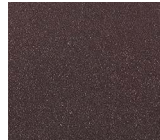

Textured White

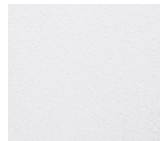

Matte Silver

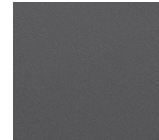

Sand

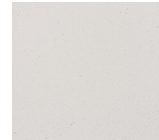

Swedish Steel

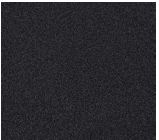

For RAL Colors & Custom Match - Contact Teron Lighting Inc.

GUARDIAN W CNL LED 50"

Architectural Outdoor



Fixture Core

PROJECT:	
TYPE:	
PO#:	QTY:
COMMENTS:	

PRODUCT CODE	SOURCE/WATTAGE	VOLTAGE	DIMMING DRIVER
GRDW48 - Guardian W 50"	L70.0-ZE1050 - 70.0W @ Line Voltage 4-Wire Dimming Driver (Dimmable 0 - 10V) L75.0-ZE1100 - 75.0W @ Line Voltage 4-Wire Dimming Driver (Dimmable 0 - 10V)	120 - 277V 347V (Available For L70.0 Only)	Not Applicable
ORDER INFO			
GRDW48	L70.0-ZE1050	120 - 277V	Not Applicable

Example ^ (may not represent a manufacturable product)

Aesthetics & Options

TRIM	FINISH	COLOR TEMP	OPTIONS
CNL	AC - Antique Copper TB - Textured Black AS - Antique Silver BT - Bronze Mist BZ - Textured Bronze SM - Matte Silver (Standard) TW - Textured White SN - Sand SW - Swedish Steel	30K - 3000K Color Temp 35K - 3500K Color Temp 40K - 4000K Color Temp 50K - 5000K Color Temp	OEL - Single End Window TEL - Twin End Windows (Both Ends) EB10 - Iota ILB-CP10-B Integral 10W LED Driver MSI - Steinel HFLUM2-WR Internal Motion Sensor
ORDER INFO			
CNL	AC	30K	OEL

Example ^ (may not represent a manufacturable product)

PROD	SOURCE	30K SPECS				
GRDW48	L70.0	<ul style="list-style-type: none"> 80 CRI Typ. 30K - 3000K Color Temp 5693 LED Source Lumens 81.3 LED Source Lumens Per Watt 				
	L75.0	<ul style="list-style-type: none"> 80 CRI Typ. 30K - 3000K Color Temp 5964 LED Source Lumens 79.5 LED Source Lumens Per Watt 				

REPLACEMENT PART	PART NO	NOTES
4' Acrylic LED Lens Assembly	38218	
		Don't see the configuration you are looking for? Call us today at (513) 858-6004



TERONLIGHTING.COM
 33 DONALD DR, FAIRFIELD, OH 45014
 P: 513.858.6004 F: 513.858.6038
 E: SALES@TERONLIGHT.COM



We reserve the right to revise the design components of any product due to parts availability or change in UL standards, without assuming any obligation or liability to modify any products previously manufactured, and without notice.