

AZINGER 36"

Architectural Indoor



PROJECT:	
TYPE:	
PO#:	QTY:
COMMENTS:	

FEATURES

- Steel Trim w/ Swedish Steel Powder Coat Finish
- Steel Housing w/ White Powder Coat Finish
- Steel Reflector w/ Hi-Reflectance White Powder Coat Finish
- Luminous White Acrylic Diffuser
- Mounts Directly to Surface w/ Two Wall Anchors (Not Included)
- ADA Compliant
- CSA Listed Damp Location For Surface Mount
- Emergency Battery Available



LINE DRAWING

LINE DRAWING NOT TO SCALE

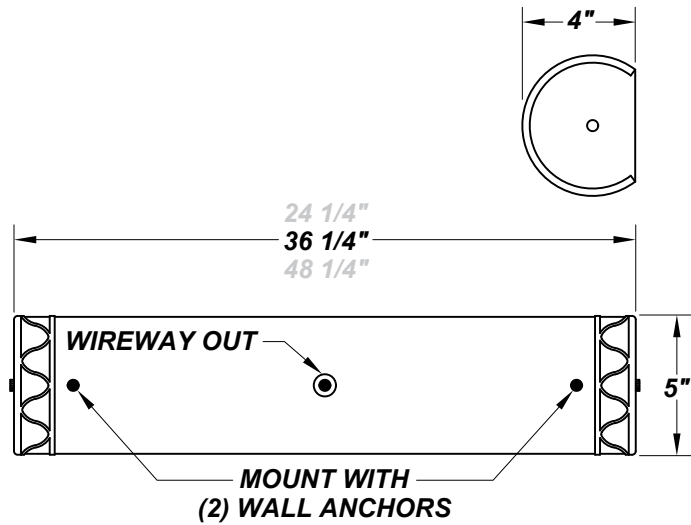

FINISHES

Antique Copper	Antique Silver	Bronze Mist	Matte Silver	Metallic Black	Sand
Swedish Steel	Textured Black	Textured Bronze	Textured White		

For RAL Colors & Custom Match - Contact Teron Lighting Inc.



AZINGER 36"

Architectural Indoor



Fixture Core

PROJECT:	
TYPE:	
PO#:	QTY:
COMMENTS:	

PRODUCT CODE	SOURCE/WATTAGE	VOLTAGE	DIMMING BALLAST
AR36 - Azinger 36"	125E - (1) 25W T8 225E - (2) 25W T8 221E - (2) 21W T5 239E-HO - (2) 39W T5 HO (High-Output)	120V 277V	Not Applicable
ORDER INFO			
AR36	125E	120V	Not Applicable

Example ^ (may not represent a manufacturable product)

Aesthetics & Options

TRIM	FINISH	COLOR TEMP	OPTIONS
Not Applicable	AC - Antique Copper AS - Antique Silver BT - Bronze Mist SM - Matte Silver MB - Metallic Black SN - Sand SW - Swedish Steel (Standard) TB - Textured Black BZ - Textured Bronze TW - Textured White	Not Applicable	DIM - Dimming Balast (132E & 232E Only) EBR - Remote Mount Battery (Field Installed) EBW - Integral Emergency Battery F - Fused W2L - Wire 2 Lamps to Integral Emergency Battery (T8 Lamping Only)
ORDER INFO			
Not Applicable	AC	Not Applicable	DIM

Example ^ (may not represent a manufacturable product)

REPLACEMENT PART	PART NO	NOTES
36" White Acrylic Diffuser	3018560	

Don't see the configuration you are looking for?
Call us today at (513) 858-6004



TERONLIGHTING.COM
 33 DONALD DR, FAIRFIELD, OH 45014
 P: 513.858.6004 F: 513.858.6038
 E: SALES@TERONLIGHT.COM



We reserve the right to revise the design components of any product due to parts availability or change in UL standards, without assuming any obligation or liability to modify any products previously manufactured, and without notice.