

CAPRI 48"

Architectural Indoor



PROJECT:	
TYPE:	
PO#:	QTY:
COMMENTS:	

FEATURES

- Steel Housing w/ Matte Silver Powder Coat Finish
- Steel Mounting Pan w/ Hi-Reflectance White Powder Coat Finish
- Luminous White Acrylic Diffuser
- Steel Reflector w/ Hi-Reflectance White Powder Coat Finish
- Mounts Directly to Surface w/ Two Wall Anchors (Not Included)
- Lamps Not Included
- ADA Compliant
- CSA Listed Damp Location For Wall or Ceiling Mounting (Ceiling Mount Not Available For T5 HO Lamping)
- Emergency Battery Available
- Vandal Resistant

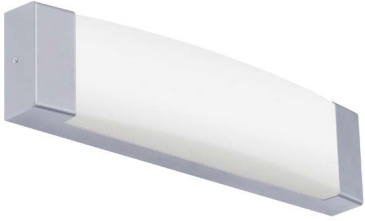

LINE DRAWING

LINE DRAWING NOT TO SCALE

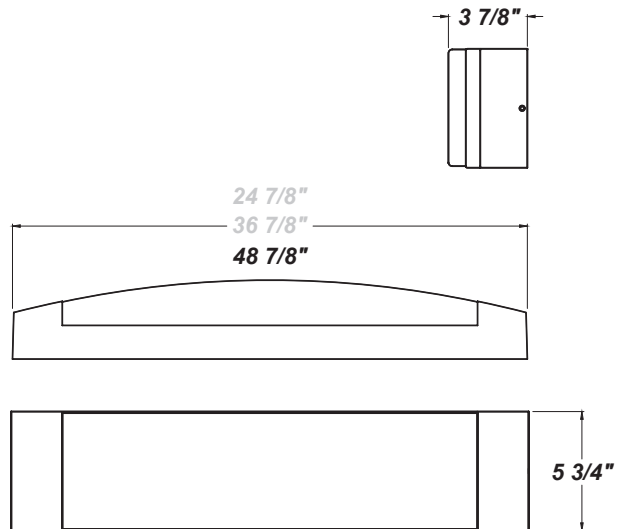

FINISHES

Antique Copper	Antique Silver	Bronze Mist	Matte Silver	Metallic Black	Sand
Swedish Steel	Textured Black	Textured Bronze	Textured White		

For RAL Colors & Custom Match - Contact Teron Lighting Inc.

CAPRI 48"

Architectural Indoor



Fixture Core

PROJECT:	
TYPE:	
PO#:	QTY:
COMMENTS:	

PRODUCT CODE	SOURCE/WATTAGE	VOLTAGE	DIMMING BALLAST
CPR48 - Capri 48"	232E - (2) 32W T8 228E - (2) 28W T5 254E-HO - (2) 54W T5 HO (High-Output)	120V 277V	Not Applicable
ORDER INFO			
CPR48	232E	120V	Not Applicable

Example ^ (may not represent a manufacturable product)

Aesthetics & Options

TRIM	FINISH	COLOR TEMP	OPTIONS
Not Applicable	AC - Antique Copper AS - Antique Silver BT - Bronze Mist SM - Matte Silver (Standard) MB - Metallic Black SN - Sand SW - Swedish Steel TB - Textured Black BZ - Textured Bronze TW - Textured White	Not Applicable	DIM - Dimming Ballast (232E & 228E Only) EBR - Remote Mount Battery (Field Installed) F - Fused TP - Tamper Resistant Screws
ORDER INFO			
Not Applicable	AC	Not Applicable	DIM

Example ^ (may not represent a manufacturable product)

REPLACEMENT PART	PART NO	NOTES
White 4' Acrylic Diffuser	3040460	

Don't see the configuration you are looking for?
Call us today at (513) 858-6004



TERONLIGHTING.COM
33 DONALD DR, FAIRFIELD, OH 45014
P: 513.858.6004 F: 513.858.6038
E: SALES@TERONLIGHT.COM



We reserve the right to revise the design components of any product due to parts availability or change in UL standards, without assuming any obligation or liability to modify any products previously manufactured, and without notice.