

| |
|--------------|
| PROJECT : |
| TYPE : |
| ORDERING # : |
| COMMENTS : |

TURNBERRY CNL

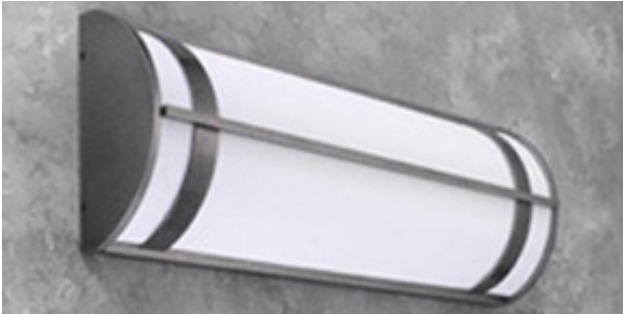

Textured Bronze Finish Shown

LINEAR FLUORESCENT

FEATURES

- Die-Formed Steel Housing w/ Textured White Powder Coat Finish
- Aluminum Trim w/ Textured White Powder Coat Finish
- Die-Cast Aluminum End Caps w/ Recessed Screw Holes & Textured White Powder Coat Finish
- High Impact White Acrylic Diffuser (50% DR Acrylic)
- Mounts Directly to Wall or Ceiling w/ Four Wall Anchors (Not Included)
- Lens Can be Removed and Replaced Without Sliding Length of Fixture
- Maintenance-Friendly For Tight Corners
- Integral EM Battery Available (38" & 50" Fixtures Only)
- CSA Listed Damp Location
- Wattages With a (ES) Are Available @ 120V With Energy Star Compliant Ballasts (Must be used with lamps that have an average rated life of 10,000 hours or more)

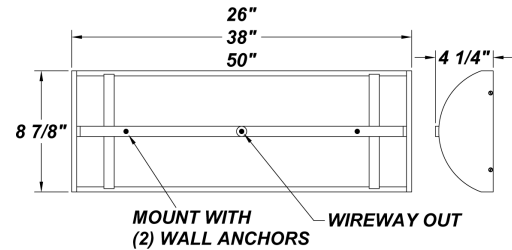

ORDERING INFORMATION

Example : (TRN - CNL - 48232E - 120E - SM)

Textured White is Standard Finish

| PRODUCT | SOURCE/WATTAGE | VOLTAGE | DIFFUSER | FINISH | OPTIONS |
|-------------------|---|--|----------------|---|--|
| Turnberry CNL 26" | TRN-CNL-24217E - (2) 17W T8 (ES) TRN-CNL-24214E - (2) 14W T5 TRN-CNL-24224E - HO* - (2) 24W T5 | 120E - 120V Electronic 277E - 277V Electronic | Not Applicable | SM - Matte Silver TB - Textured Black AC - Antique Copper AS - Antique Silver BT - Bronze Mist CP - Copper KC - Kenworth Chrome SN - Sand SW - Swedish Steel BZ - Textured Bronze TW - Textured White RAL Colors or Custom Match - Consult Factory | MS - Motion Sensor - Wattstopper FS-505 (See Turnberry CNL Sensor Cutsheet For Specs) EB - Integral Emergency Battery** (38" & 50" Fixtures Only) TP - Tamper Resistant Screws F - Fused W2L - Wire 2 Lamps to Integral Emergency Battery |
| Turnberry CNL 38" | TRN-CNL-36225E - (2) 25W T8 (ES) TRN-CNL-36221E - (2) 21W T5 TRN-CNL-36239E - HO* - (2) 39W T5 | | | | |
| Turnberry CNL 50" | TRN-CNL-48232E - (2) 32W T8 (ES) TRN-CNL-48228E - (2) 28W T5 TRN-CNL-48254E - HO* - (2) 54W T5 *HO - High Output | | | | |

REPLACEMENT PARTS

PART NO.

| | |
|----------------------------|---------|
| 24" White Acrylic Diffuser | 3025960 |
| 36" White Acrylic Diffuser | 3026060 |
| 48" White Acrylic Diffuser | 3026160 |

NOTES

****Emergency Battery Options**

Initial light output in Emergency mode will last for a minimum of 90 minutes. 1 lamp wired unless ordered otherwise. The following are suitable for indoor and damp locations. Please refer to Bodine's specification sheet

EB:

Bodine's B50LP (T8 Electronic) - Temperature Rating (Ambient) 32° F - 131° F
Bodine's B550LP (T5 Electronic) - Temperature Rating (Ambient) 32° F - 122° F

ARRA 2009



We reserve the right to revise the design or components of any product due to parts availability or change in UL standards, without assuming any obligation or liability to modify any products previously manufactured, and without notice.

TURNBERRY CNL - MOTION SENSOR

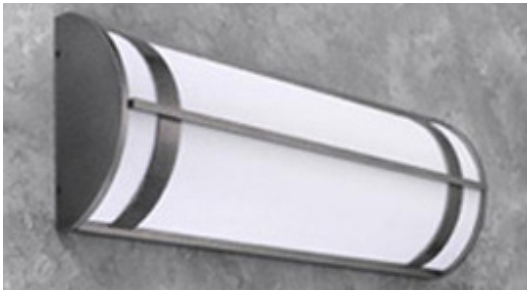

Textured Bronze Finish Shown

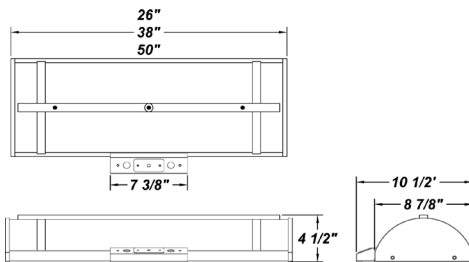

| |
|--------------|
| PROJECT : |
| TYPE : |
| ORDERING # : |
| COMMENTS : |

FEATURES

- Die-Formed Steel Housing w/ Textured White Powder Coat Finish
- High Impact White Acrylic Diffuser (50% DR Acrylic)
- Aluminum Reflector Plate w/ Hi-Reflectance White Powder Coat Finish
- Die-Cast Aluminum End Caps w/ Recessed Screw Holes
- Mounts Directly to Wall or Ceiling w/ Four Wall Anchors (Not Included)
- CSA Listed Damp Location
- Integral EM Battery Available
- Maintenance-Friendly For Tight Corners
- Lens Can be Removed and Replaced Without Sliding Length of Fixture

MOTION SENSOR SPECS

- Optional Bracket Required for Wattstopper FS-505 Motion Sensor
- Hi-Frequency Sensitive Ultrasonic
- LED Status Indicator Light
- Lamp Conditioning Circuit
- Fail-Safe Sensor Switches Light Level to 100% if Sensor is Physically Damaged
- 5-Minute Walk-Test Feature, Easy-Set
- Time / Sensitivity Controls

Please Note: TLI is Not Responsible For Misapplication of Fixture With Motion Sensors Consult Pg. 3 For Specific Application & Coverage Patterns. The FS-505 Motion Sensor is For Wall Mount Usage Only.

ORDERING INFORMATION

Example : (TRN - CNL - 48232E - 120E - SDIM50 - TB - MS)

Textured White is Standard Finish

| PRODUCT | SOURCE/WATTAGE | VOLTAGE | DIMMING CONFIG | FINISH | OPTIONS |
|---------------|---|--|--|---|---|
| Turnberry 26" | TRN-CNL-24217E - (2) 17W T8** TRN-CNL-24214E - (2) 14W T5 TRN-CNL-24224E - HO* - (2) 24W T5 | 120E - 120V Electronic 277E - 277V Electronic | SDIM10** - Lamps Set at 10% Output w/ No Occupancy & 100% Outout w/ Motion Sensor Occupancy Read (See Pg. 3) | SM - Matte Silver TB - Textured Black AC - Antique Copper AS - Antique Silver BT - Bronze Mist CP - Copper KC - Kenworth Chrome SN - Sand SW - Swedish Steel BZ - Textured Bronze TW - Textured White | MS - Motion Sensor - Wattstopper FS-505 (See Pg.2) (Requires Back Plate, Which Will Add 5/16" to Fixture Length & 1 11/16" to Fixture Depth) EB - Integral Emergency Battery** (For Use With MS2B Only) (Consult Factory For Application Specs / Battery Option) TP - Tamper Resistant Screws W2L - Wire 2 Lamps to Integral Emergency Battery |
| Turnberry 38" | TRN-CNL-36225E - (2) 25W T8 ** TRN-CNL-36221E - (2) 21W T5 TRN-CNL-36239E-HO* - (2) 39W T5 | | SDIM40** - Lamps Set at 40% Output w/ No Occupancy & 100% Outout w/ Motion Sensor Occupancy Read (See Pg. 3) | | |
| Turnberry 50" | TRN-CNL-48232E - (2) 32W T8** TRN-CNL-48228E - (2) 28W T5** TRN-CNL-48254E - HO* - (2) 54W T5 | | SDIM50** - Lamps Set at 50% Output w/ No Occupancy & 100% Outout w/ Motion Sensor Occupancy Read (See Pg. 3) | RAL Colors or Custom Match - Consult Factory | |
| | *HO - High Output ** Wattages Available For "SDIM" Option | | MS2B - 1 Lamp at 100% Constant Output, and 1 Lamp Connected to Motion Sensor (Requires 2 Ballasts) Please Refer to Page 2 for Step-Dim & MS2B Specifications, Options, and Restrictions | | |

ARRA 2009



BUY AMERICA ACT

| |
|--------------|
| PROJECT : |
| TYPE : |
| ORDERING # : |
| COMMENTS : |

TURNBERRY CNL SENSOR

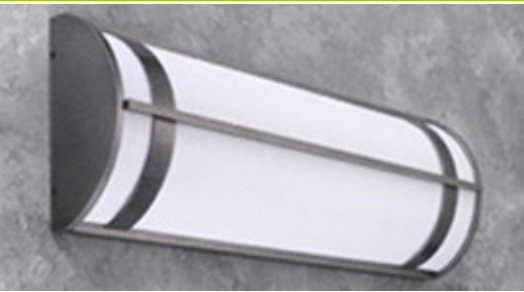

DIMMING APPLICATIONS & RESTRICTIONS

- Step-Dimming is available at 10% and 40% for 25W and 32W T8 linear lamps
 - Emergency Battery is not available for use with the 10% and 40% Step-Dim option
 - Ballast used is the **Robertson brand #PSL232T8MV3D**
- Step-Dimming is available at 50% for 17W, 25W, and 32W T8 Linear Lamps
 - Emergency Battery is available for use with the 50% Step-Dim option
 - Ballast used is the **Universal brand #B232PUS50-A**
- Step-Dimming is available at 50% for 28W T5 Linear Lamps
 - Emergency Battery is available for use with the 50% Step-Dim option
 - Ballast used is the **Philips Advance brand #IOP-2S28-95-SC-SD**
- All 3 ballasts meet California's Title 24 requirement by reducing power by 50% or more

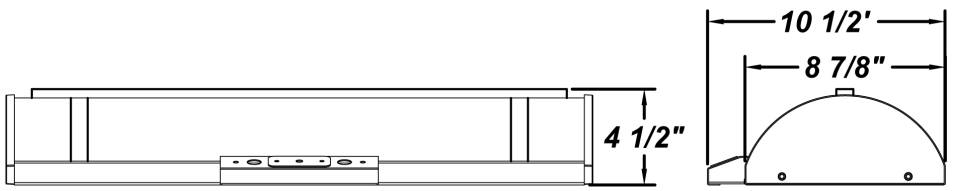
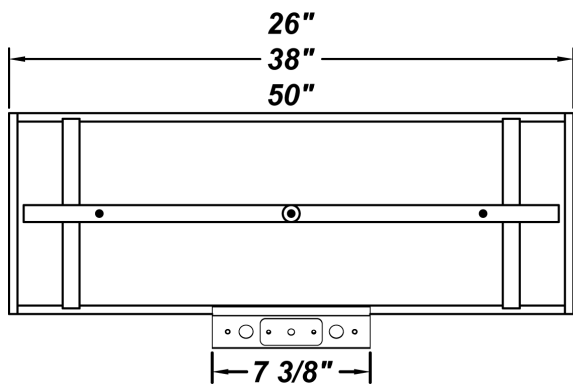

MOTION SENSOR WITH 2 BALLASTS "MS2B" APPLICATIONS & RESTRICTIONS

- The "MS2B" option is intended to have one lamp providing 100% constant light output, while the other lamp is connected to the Motion Sensor. Two ballasts are required with this option
- Emergency Battery is available in conjunction with the "MS2B" option for 38" and 50" fixtures
- Emergency battery is not available for 26" fixtures in conjunction with the "MS2B" option due to fixture space restrictions

| REPLACEMENT PARTS | PART NO. |
|----------------------------|----------|
| 26" White Acrylic Diffuser | 3025960 |
| 38" White Acrylic Diffuser | 3026060 |
| 50" White Acrylic Diffuser | 3026160 |

| NOTES |
|---|
| <p>Emergency Battery Options</p> <p>Initial light output in Emergency mode will last for a minimum of 90 minutes. 1 lamp wired unless ordered otherwise. The following are suitable for indoor and damp locations. Please refer to Bodine's specification sheet</p> <p>EB:</p> <p>Bodine's B50 (Electronic) - Temperature Rating (Ambient) 32° F - 131° F</p> <p>Bodine's B550LP (T5 Electronic) - Temperature Rating (Ambient) 32° F - 122°F</p> |

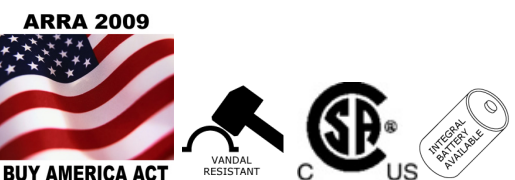

We reserve the right to revise the design or components of any product due to parts availability or change in UL standards, without assuming any obligation or liability to modify any products previously manufactured, and without notice.

FS-505



DESCRIPTION AND OPERATION

The FS-505 and FS-505C occupancy sensors turn lighting on and off based on occupancy. The sensors use ultrasonic sensing technology. Once the space is vacant and the time delay elapses (adjustable from 5 to 30 minutes), lights will turn off.

The FS-505 and FS-505C operate at 24VDC. They are designed for installation in a light fixture within 2 feet of an associated power supply. The power supply for the sensors is a FS-PP power pack mounted inside a light fixture. Each Watt Stopper FS-PP power pack can supply power for one FS-505 or FS-505C.

The sensors are equipped with a 2' long cable fitted with a shielded male RJ45 plug. The FS-PP has a corresponding female RJ45 receptacle. This cable carries power to the sensor and the 24VDC maintained output to the power pack to signal that lights should be on. Optional cables and connectors are available for alternate configurations.

Important, there is an initial warm-up period:

It may take up to a minute before the lights turn on due to a sensor warm-up period required during initial power-up. This occurs during installation or after a lengthy power failure only.

APPLICATION

The FS-505 (no cones) is designed for use in wall-mounted lighting fixtures where the transducers face away from the wall at an angle of approximately 20° from vertical. It is particularly well suited for use in stairwell applications as well as in other wall mount applications.

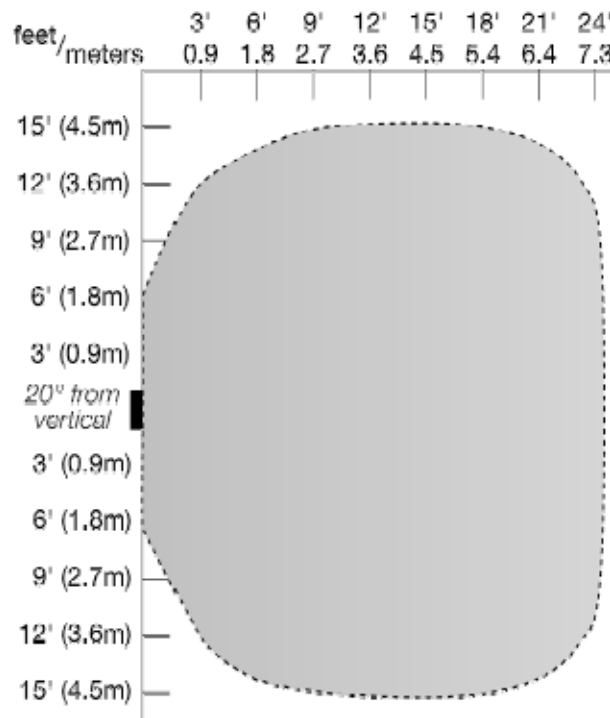
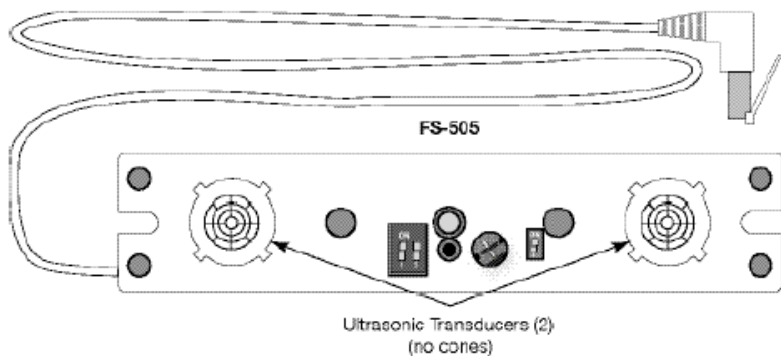

Top view, FS-505 coverage pattern, sensor mounted 20° from vertical

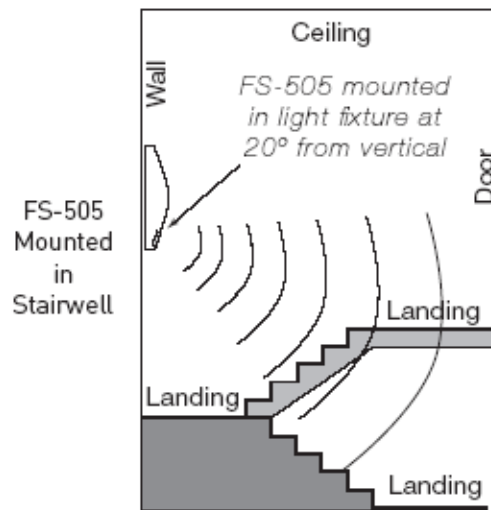

COVERAGE PATTERN

The coverage pattern is determined by sensor model, mounting height and the angle of the sensor, relative to the coverage area floor.

The coverage shown represents full-step walking motion in a carpeted area, with no barriers or obstacles at a mounting height of 8 to 10 feet. Mounting above or below this range significantly affects coverage patterns.

Obstacles such as furniture or partitions, wall, ceiling and floor treatments can cause the coverage area to be less or more than the sensing distances shown in the coverage pattern. This must be considered when planning the number of sensors and their placement.

Place sensors at least 4 feet away from air supply ducts.

For complete coverage in open areas, install multiple sensors to provide a 20% overlap with each adjacent sensor's coverage area.



Call 800.879.8585 or 972.578.1699
for Technical Support