

TURNBERRY MSE LED 26"

Architectural Indoor



PROJECT:	
TYPE:	
PO#:	QTY:
COMMENTS:	



FEATURES

- 120V - 277V
- ADA Compliant
- Aluminum LED Mounting Plate
- CSA Listed Damp Location For Wall or Ceiling Mount
- Die-Formed Steel Housing w/ Textured White Polyester Powder Coat Finish
- Die Cast Aluminum End Caps w/ Textured White Polyester Powder Coat Finish
- Emergency Driver Available
- [External Motion Sensor](#)
- Fixture Mounts Directly to Surface w/ Two Wall Anchors (Not Included)
- High Impact White Acrylic Diffuser (50% DR Acrylic) w/ Inner Frosted Diffuser
- LED Light Fixture
- Recessed Stainless Steel Screws
- Surge Protector

LINE DRAWING

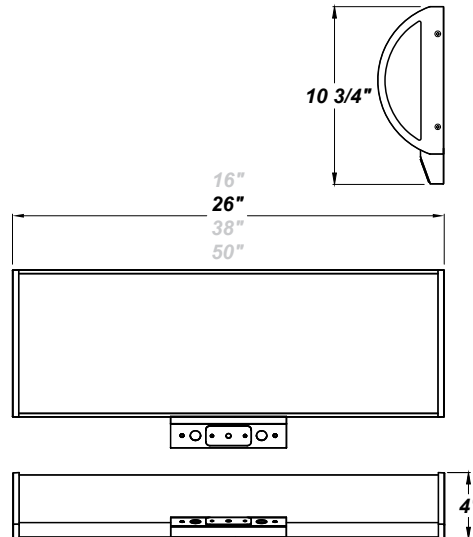

LINE DRAWING NOT TO SCALE

FINISHES

Antique Copper

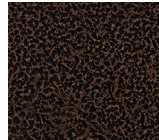

Antique Silver

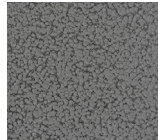

Bronze Mist



Matte Silver

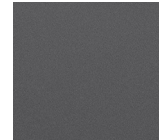

Sand

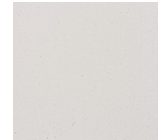

Swedish Steel

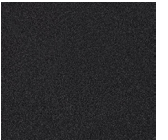

Textured Black

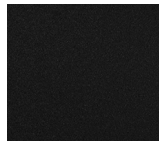

Textured Bronze

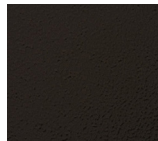

Textured White

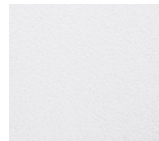

For RAL Colors & Custom Match - Contact Teron Lighting Inc.

TURNBERRY MSE LED 26"

Architectural Indoor



Fixture Core

PROJECT:	
TYPE:	
PO#:	QTY:
COMMENTS:	

PRODUCT CODE	SOURCE/WATTAGE	VOLTAGE	DIMMING DRIVER
TRN26 - Turnberry 26"	L24.0-ZE700 - 24.0W LED Strip(s) @ 700mA Line Voltage 4-Wire Dimming Driver (Dimmable 0 - 10V) ** L30.0-ZE900 - 30.0W LED Strip(s) @ 900mA Line Voltage 4-Wire Dimming Driver (Dimmable 0 - 10V) ** L34.0-ZE1000 - 34.0W LED Strip(s) @ 1000mA Line Voltage 4-Wire Dimming Driver (Dimmable 0 - 10V) **	120-277V (50 / 60Hz)	Not Applicable
ORDER INFO			
TRN26	L19.0-ZE600	120-277V	Not Applicable

Example ^ (may not represent a manufacturable product)

Aesthetics & Options

TRIM	FINISH	COLOR TEMP	OPTIONS
Not Applicable	AC - Antique Copper TW - Textured White (Standard) AS - Antique Silver BT - Bronze Mist SM - Matte Silver SN - Sand SW - Swedish Steel TB - Textured Black BZ - Textured Bronze	30K - 3000K Color Temp 35K - 3500K Color Temp 40K - 4000K Color Temp	EB10 - Iota ILB-CP10 10W LED Driver F - Fused MSE - WattStopper FS-505 External Motion Sensor (Will Add 1 11/16" to Fixture Depth) OEL - Single End Window TEL - Twin End Windows (Both Ends) TP - Tamper Resistant Screws
ORDER INFO			
Not Applicable	AC	27K	EB10

Example ^ (may not represent a manufacturable product)

PROD	SOURCE	30K SPECS				
TRN26	L24.0	<ul style="list-style-type: none"> 30K - 3000K Color Temp 795 LED Source Lumens 158.1 LED Source Lumens Per Watt 				
	L30.0	<ul style="list-style-type: none"> 30K - 3000K Color Temp 4879 LED Source Lumens 162.6 LED Source Lumens Per Watt 				
	L34.0	<ul style="list-style-type: none"> 30K - 3000K Color Temp 5421 LED Source Lumens 159.4 LED Source Lumens Per Watt 				

REPLACEMENT PART	PART NO	NOTES
2' Acrylic LED Lens Assembly	38216	** EB Option Available
Frosted Polycarbonate End Diffuser (For OEL / TEL)	3410862	

Don't see the configuration you are looking for?
Call us today at (513) 858-6004



TERONLIGHTING.COM
 33 DONALD DR, FAIRFIELD, OH 45014
 P: 513.858.6004 F: 513.858.6038
 E: SALES@TERONLIGHT.COM



We reserve the right to revise the design components of any product due to parts availability or change in UL standards, without assuming any obligation or liability to modify any products previously manufactured, and without notice.