

# TURNBERRY MSE LED 16"

Architectural Indoor



PROJECT:	
TYPE:	
PO#:	QTY:
COMMENTS:	



## FEATURES

- 120V - 277V
- ADA Compliant
- Aluminum LED Mounting Plate
- CSA Listed Damp Location For Wall or Ceiling Mount
- Die-Formed Steel Housing w/ Textured White Polyester Powder Coat Finish
- Die Cast Aluminum End Caps w/ Textured White Polyester Powder Coat Finish
- [External Motion Sensor](#)
- Fixture Mounts Directly to Surface w/ Two Wall Anchors (Not Included)
- High Impact White Acrylic Diffuser (50% DR Acrylic) w/ Inner Frosted Diffuser
- Recessed Stainless Steel Screws
- Surge Protector



## LINE DRAWING

LINE DRAWING NOT TO SCALE

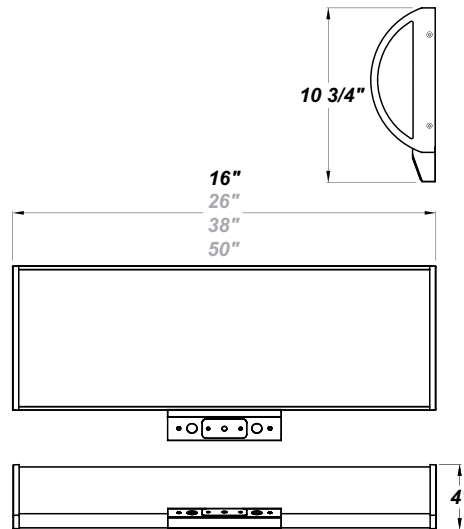

## FINISHES

Antique Copper



Antique Silver



Bronze Mist

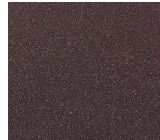

Matte Silver

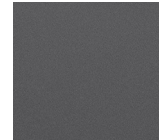

Sand

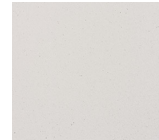

Swedish Steel

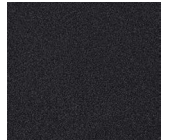

Textured Black

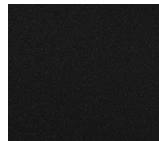

Textured Bronze

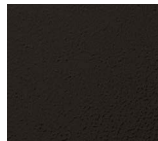

Textured White

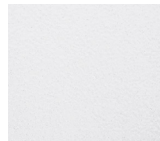

For RAL Colors & Custom Match - Contact Teron Lighting Inc.

# TURNBERRY MSE LED 16"

Architectural Indoor



Fixture Core

PROJECT:	
TYPE:	
PO#:	QTY:
COMMENTS:	

PRODUCT CODE	SOURCE/WATTAGE	VOLTAGE	DIMMING DRIVER
TRN16 - Turnberry 16"	<b>L19.0-ZE600</b> - 19.0W LED Strip(s) @ 600mA Line Voltage 4-Wire Dimming Driver (Dimmable 0 - 10V) <b>L22.0-TE700</b> - 22.0W LED Strip(s) @ 700mA ELV Low Voltage 2-Wire Dimming Electronic Driver (Trailing Edge)	<b>120-277V</b> (50 / 60Hz)	<b>Not Applicable</b>
ORDER INFO			
TRN16	L19.0-ZE600	120-277V	Not Applicable

Example ^ (may not represent a manufacturable product)

Aesthetics & Options

TRIM	FINISH	COLOR TEMP	OPTIONS
<b>Not Applicable</b>	<b>AC</b> - Antique Copper <b>TB</b> - Textured Black <b>AS</b> - Antique Silver <b>BT</b> - Bronze Mist <b>BZ</b> - Textured Bronze <b>SM</b> - Matte Silver <b>TW</b> - Textured White (Standard) <b>SN</b> - Sand <b>SW</b> - Swedish Steel	<b>30K</b> - 3000K Color Temp <b>35K</b> - 3500K Color Temp <b>40K</b> - 4000K Color Temp <b>50K</b> - 5000K Color Temp	<b>F</b> - Fused <b>MSE</b> - WattStopper FS-505 External Motion Sensor (Will Add 1 11/16" to Fixture Depth) <b>OEL</b> - Single End Window <b>TEL</b> - Twin End Windows (Both Ends) <b>TP</b> - Tamper Resistant Screws
ORDER INFO			
Not Applicable	AC	30K	F

Example ^ (may not represent a manufacturable product)

PROD	SOURCE	30K SPECS			
TRN16	L19.0	<ul style="list-style-type: none"> <li>30K - 3000K Color Temp</li> <li>2981 LED Source Lumens</li> <li>157 LED Source Lumens Per Watt</li> </ul>			
	L22.0	<ul style="list-style-type: none"> <li>30K - 3000K Color Temp</li> <li>3478 LED Source Lumens</li> <li>158 LED Source Lumens Per Watt</li> </ul>			

REPLACEMENT PART	PART NO	NOTES
16" Acrylic LED Lens Assembly	38200	
Frosted Polycarbonate End Diffuser (For OEL / TEL)	3410862	

Don't see the configuration you are looking for?  
Call us today at (513) 858-6004



TERONLIGHTING.COM  
 33 DONALD DR, FAIRFIELD, OH 45014  
 P: 513.858.6004 F: 513.858.6038  
 E: SALES@TERONLIGHT.COM



We reserve the right to revise the design components of any product due to parts availability or change in UL standards, without assuming any obligation or liability to modify any products previously manufactured, and without notice.