

BISCAYNE MSI LED 25"

Architectural Indoor



PROJECT:	
TYPE:	
PO#:	QTY:
COMMENTS:	



FEATURES

- [Internal Motion Sensor](#)
- Steel Housing and End Caps with Matte Silver Powder Coat Finish
- High Impact, Fine Ribbed, Frosted Acrylic Diffuser
- Steel Reflector Plate with Hi-Reflectance White Powder Coat Finish
- Mounts Directly to Wall or Ceiling with Four Wall Anchors (Not Included)
- Standard Ballast Configuration for Motion Sensor is 100% to 0% Up /Down Light
- ADA Compliant
- CSA Listed Damp Location For Wall or Ceiling Mount
- LED Light Fixture
- Internal Motion Sensor
- Vandal Resistant



LINE DRAWING

LINE DRAWING NOT TO SCALE

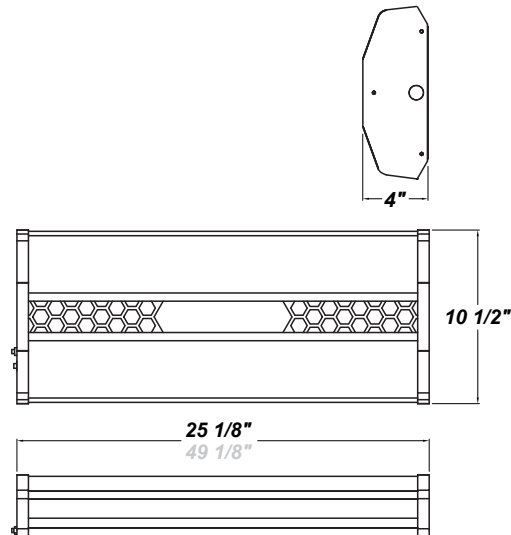

FINISHES

Antique Copper

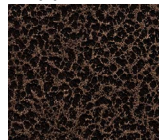

Antique Silver

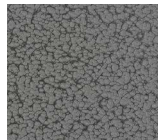

Bronze Mist



Matte Silver



Sand

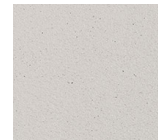

Swedish Steel



Textured Black

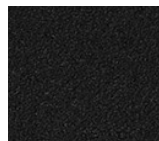

Textured Bronze

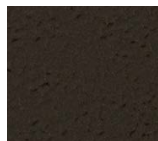

Textured White

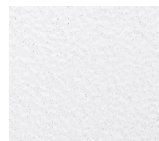

For RAL Colors & Custom Match - Contact Teron Lighting Inc.

BISCAYNE MSI LED 25"

Architectural Indoor



Fixture Core

PROJECT:	
TYPE:	
PO#:	QTY:
COMMENTS:	

PRODUCT CODE	SOURCE/WATTAGE	VOLTAGE	DIMMING BALLAST
BSC24 - Biscayne 25"	L38.3-ZE1050 - 42W @ 1050mA Constant Current Dimming Electronic Driver (Dimmable 0-10V) L34.7-TE950 - 40W @ 950mA Constant Current ELV Dimming Electronic Driver	120V 277V (50 / 60Hz)	SDxx - Bi-Level Step Dimming from 10-90% in increments of 10% (replace xx in ordering code with requested dimming percentage)
ORDER INFO			
BSC24	L38.3-ZE1050	120V	SD50

Example ^ (may not represent a manufacturable product)

Aesthetics & Options

TRIM	FINISH	COLOR TEMP	OPTIONS
MSI - Internal Motion Sensor (Steinel HFLUM2-WR) HCB MSI - Honeycomb Pattern w/ Internal Motion Sensor DMD MSI - Diamond Pattern w/ Internal Motion Sensor PRF MSI - Perforated Pattern w/ Internal Motion Sensor	AC - Antique Copper AS - Antique Silver BT - Bronze Mist SM - Matte Silver (Standard) SN - Sand SW - Swedish Steel TB - Textured Black BZ - Textured Bronze TW - Textured White	27K - 2700K Color Temp. 30K - 3000K Color Temp. 35K - 3500K Color Temp. 40K - 4000K Color Temp. 51K - 5100K Color Temp.	FAL - Frosted Acrylic Lens (Standard) WAL - Frosted & White Acrylic Lens Assembly EB - BSL310 Emergency Driver TP - Tamper Resistant Screws F - Fused
ORDER INFO			
MSI	AC	35K	FAL-WAL

Example ^ (may not represent a manufacturable product)

PROD	SOURCE	27K SPECS	30K SPECS	35K SPECS	40K SPECS	51K SPECS
BSC24	L38.3-ZE1050	<ul style="list-style-type: none"> 27K - 2700K Color Temp. Nominal 3015 Estimated Delivered Lumens 44.56 Estimated Delivered Lumens Per Watt 	<ul style="list-style-type: none"> 30K - 3000K Color Temp. Nominal 3071 Delivered Lumens 44.56 Delivered Lumens Per Watt 	<ul style="list-style-type: none"> 35K - 3500K Color Temp. Nominal 3127 Estimated Delivered Lumens 44.56 Estimated Delivered Lumens Per Watt 	<ul style="list-style-type: none"> 40K - 4000K Color Temp. Nominal 3239 Estimated Delivered Lumens 44.56 Estimated Delivered Lumens Per Watt 	<ul style="list-style-type: none"> 50K - 5000K Color Temp. Nominal 3350 Estimated Delivered Lumens 44.56 Estimated Delivered Lumens Per Watt

REPLACEMENT PART	PART NO	NOTES
Frosted 2' Acrylic Diffuser	3029662	*Don't see the configuration you are looking for? Call us today at (513) 858-6004
White 2' Acrylic Lens Assembly	38112	



TERONLIGHTING.COM
 33 DONALD DR, FAIRFIELD, OH 45014
 P: 513.858.6004 F: 513.858.6038
 E: SALES@TERONLIGHT.COM



We reserve the right to revise the design components of any product due to parts availability or change in UL standards, without assuming any obligation or liability to modify any products previously manufactured, and without notice.

BISCAYNE MSI LED 25"

Architectural Indoor



PROJECT:	
TYPE:	
PO#:	QTY:
COMMENTS:	



Biscayne DMD MSI



Biscayne HCB MSI



Biscayne HCB MSI