

BISCAYNE MSI 49"

Architectural Indoor



PROJECT:	
TYPE:	
PO#:	QTY:
COMMENTS:	



FEATURES

- [Internal Motion Sensor](#)
- Steel Housing and End Caps with Matte Silver Powder Coat Finish
- High Impact, Fine Ribbed, Frosted Acrylic Diffuser
- Steel Reflector Plate with Hi-Reflectance White Powder Coat Finish
- Mounts Directly to Wall or Ceiling with Four Wall Anchors (Not Included)
- Standard Ballast Configuration for Motion Sensor is 100% to 0% Up / Down Light
- ADA Compliant
- CSA Listed Damp Location For Wall or Ceiling Mount
- Vandal Resistant



LINE DRAWING

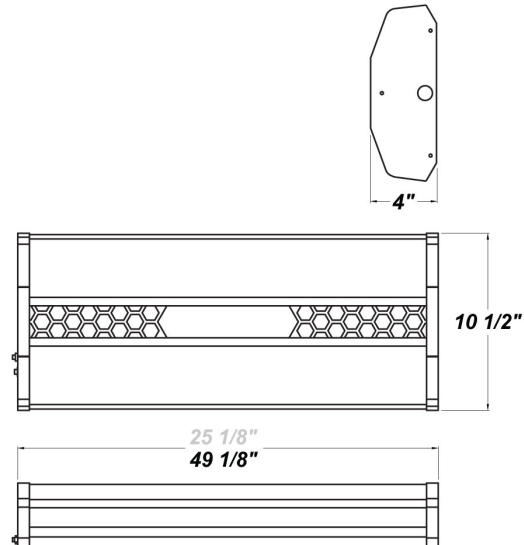

FINISHES

Antique Copper

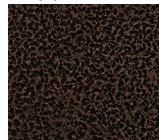

Antique Silver

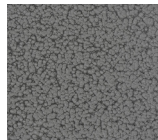

Bronze Mist

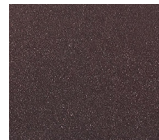

Matte Silver

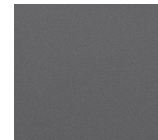

Sand

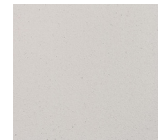

Swedish Steel

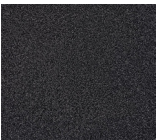

Textured Black

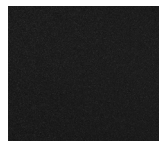

Textured Bronze



Textured White

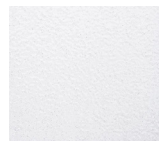

For RAL Colors & Custom Match - Contact Teron Lighting Inc.

BISCAYNE MSI 49"

Architectural Indoor



Fixture Core

PROJECT:	
TYPE:	
PO#:	QTY:
COMMENTS:	

PRODUCT CODE	SOURCE/WATTAGE	VOLTAGE	DIMMING BALLAST
BSC48 - Biscayne 49"	**228E - (2) 28W T5 **232E - (2) 32W T8 432E - (4) 32W T8 428E - (4) 28W T5 254E - HO - (2) 54W T5 High Output	120V 277V	SDIM10 - 10% Output w/ No Occupancy & 100% Output w/ Motion Sensor Occupancy (T8 only) SDIM40 - 40% Output w/ No Occupancy & 100% Output w/ Motion Sensor Occupancy (T8 only) SDIM50 - 50% Output w/ No Occupancy & 100% Output w/ Motion Sensor Occupancy
ORDER INFO			
BSC48	**228E	120	SDIM10

Example ^ (may not represent a manufacturable product)

Aesthetics & Options

TRIM	FINISH	COLOR TEMP	OPTIONS
MSI - Internal Motion Sensor (Steinel HFLUM2-WR) HCB MSI - Honeycomb Pattern w/ Internal Motion Sensor DMD MSI - Diamond Pattern w/ Internal Motion Sensor PRF MSI - Perforated Pattern w/ Internal Motion Sensor	AC - Antique Copper AS - Antique Silver BT - Bronze Mist SM - Matte Silver (Standard) SN - Sand SW - Swedish Steel TB - Textured Black BZ - Textured Bronze TW - Textured White	Not Applicable	FAL - Frosted Acrylic Lens (Standard) WAL - Frosted & White Acrylic Lens Assembly TP - Tamper Resistant Screws F - Fused
ORDER INFO			
MSI	AC		FAL

Example ^ (may not represent a manufacturable product)

REPLACEMENT PART	PART NO	NOTES
Frosted 4' Acrylic Diffuser	3001562	*Don't see the configuration you are looking for? Call us today at (513) 858-6004 **Wattages Available For Step-Dimming
White 4' Acrylic Lens Assembly	38113	



TERONLIGHTING.COM
 33 DONALD DR, FAIRFIELD, OH 45014
 P: 513.858.6004 F: 513.858.6038
 E: SALES@TERONLIGHT.COM



We reserve the right to revise the design components of any product due to parts availability or change in UL standards, without assuming any obligation or liability to modify any products previously manufactured, and without notice.

BISCAYNE MSI 49"

Architectural Indoor



PROJECT:	
TYPE:	
PO#:	QTY:
COMMENTS:	



Biscayne DMD MSI



Biscayne HCB MSI



Biscayne PRF MSI