

BISCAYNE MSE 25"

Architectural Indoor



PROJECT:	
TYPE:	
PO#:	QTY:
COMMENTS:	



FEATURES

- [External Motion Sensor](#)
- Steel Housing and End Caps with Matte Silver Powder Coat Finish
- High Impact, Fine Ribbed, Frosted Acrylic Diffuser
- Steel Reflector Plate with Hi-Reflectance White Powder Coat Finish
- Mounts Directly to Wall or Ceiling with Four Wall Anchors (Not Included)
- Standard Ballast Configuration for Motion Sensor is 100% to 0% Up / Down Light
- ADA Compliant
- CSA Listed Damp Location For Wall or Ceiling Mount
- Vandal Resistant



LINE DRAWING

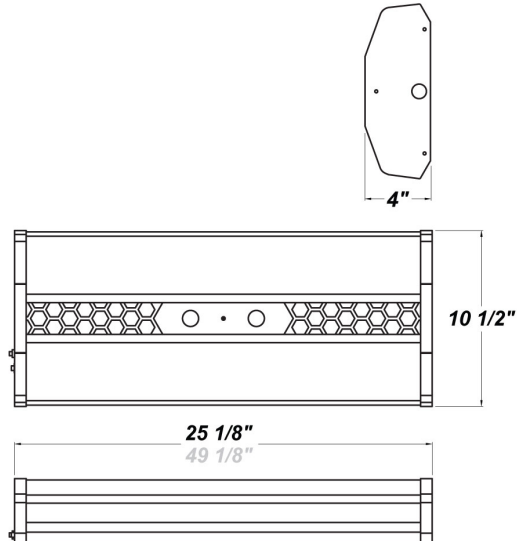

FINISHES

Antique Copper

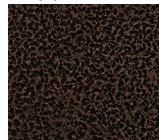

Antique Silver

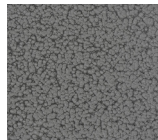

Bronze Mist

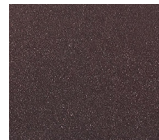

Matte Silver

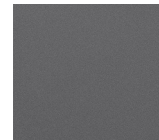

Sand

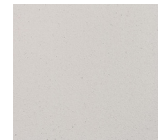

Swedish Steel

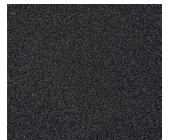

Textured Black

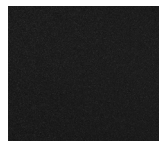

Textured Bronze



Textured White

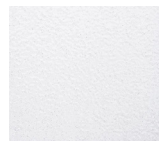

For RAL Colors & Custom Match - Contact Teron Lighting Inc.

BISCAYNE MSE 25"

Architectural Indoor



Fixture Core

PROJECT:	
TYPE:	
PO#:	QTY:
COMMENTS:	

PRODUCT CODE	SOURCE/WATTAGE	VOLTAGE	DIMMING BALLAST
BSC24 - Biscayne 25"	**214E - (2) 14W T5 **217E - (2) 17W T8 417E - (4) 17W T8 414E - (4) 14W T5 24E - HO - (2) 24W T5 High Output	120V 277V 347V	SDIM10 - 10% Output w/ No Occupancy & 100% Output w/ Motion Sensor Occupancy (T8 only) SDIM40 - 40% Output w/ No Occupancy & 100% Output w/ Motion Sensor Occupancy (T8 only) SDIM50 - 50% Output w/ No Occupancy & 100% Output w/ Motion Sensor Occupancy
ORDER INFO			
BSC24	**214E	120V	SDIM10

Example ^ (may not represent a manufacturable product)

Aesthetics & Options

TRIM	FINISH	COLOR TEMP	OPTIONS
MSE - Watt-Stopper FS505 External Motion Sensor HCB MSE - Honeycomb Pattern w/ External Motion Sensor DMD MSE - Diamond Pattern w/ External Motion Sensor PRF MSE - Perforated Pattern w/ External Motion Sensor	AC - Antique Copper AS - Antique Silver BT - Bronze Mist SM - Matte Silver (Standard) SN - Sand SW - Swedish Steel TB - Textured Black BZ - Textured Bronze TW - Textured White	Not Applicable	FAL - Frosted Acrylic Lens (Standard) WAL - Frosted & White Acrylic Lens Assembly TP - Tamper Resistant Screws F - Fused
ORDER INFO			
MSE	AC		FAL

Example ^ (may not represent a manufacturable product)

REPLACEMENT PART	PART NO	NOTES
Frosted 2' Acrylic Diffuser	3029662	*Don't see the configuration you are looking for? Call us today at (513) 858-6004 **Wattages Available For Step-Dimming
White 2' Acrylic Lens Assembly	38112	



TERONLIGHTING.COM
 33 DONALD DR, FAIRFIELD, OH 45014
 P: 513.858.6004 F: 513.858.6038
 E: SALES@TERONLIGHT.COM



We reserve the right to revise the design components of any product due to parts availability or change in UL standards, without assuming any obligation or liability to modify any products previously manufactured, and without notice.

BISCAYNE MSE 25"

Architectural Indoor



PROJECT:	
TYPE:	
PO#:	QTY:
COMMENTS:	



Biscayne DMD MSE



Biscayne HCB MSE



Biscayne PRF MSE