

PROJECT :
TYPE :
ORDERING # :
COMMENTS :

18" CHELSEA SEMI-FLUSH



FEATURES



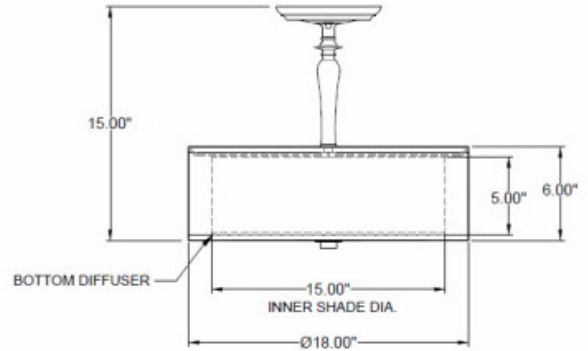







- 6.875" Cast Zinc Canopy
- Steel Trim w/ Satin Nickel Finish
- White Butcher Linen Inner Shade w/ Silver Organza Outer Shade
- Acrylic Diffuser Included
- Mounting Hardware Included
- 2 Medium Base Sockets
- For Use With Incandescent, Compact Fluorescent, or LED Screw-In Lamp (Lamps Not Included)
- Use Lamping up to:
 - 100W Incandescent
 - 27W Compact Fluorescent
 - 19W LED
- Optional GU Base Socket Adaptor Available (Must be Used With 120V Only)
- Dry Location



ORDERING INFORMATION

Example : (SF-A120 - 151-97 - 143 - SN - WBL)

Silver Organza w/ White Butcher Linen is Standard

PRODUCT	INNER SHADE	STYLE	TRIM FINISH	OUTER SHADE	OPTION	
Semi-Flush & Hardware (SF-A120)	151-56 - Gold Organza 	143 - 18" Silhouette Semi-Flush Mount	SN - Satin Nickel (Standard) OB - Oil Brushed Bronze	GO - Gold Organza	GUA - GU-Base Socket Adaptor	
	151-97 - Silver Organza 			SO - Silver Organza		
	115-01 - White Butcher Linen 			115-62 - Black Butcher Linen 		WBL - White Butcher Linen
	115-96 - Red Butcher Linen 			115-05 - Off White Butcher Linen 		BBL - Black Butcher Linen
	174-25 - Chocolate Silk Shantung 			136-33 - Oyster Silksheen 		RBL - Red Butcher Linen
	146-13 - Buff Odyssey 			180-05 - Camelot Off-White Hardback 		OBL - Off White Butcher Linen
160-04 - Natural Bombay 			CSS - Chocolate Silk Shantung			
				OS - Oyster Silksheen		
				BO - Buff Odyssey		
				COH - Camelot Off-White Hardback		
				NB - Natural Bombay		

ARRA 2009



BUY AMERICA ACT

NOTES

We reserve the right to revise the design or components of any product due to parts availability or change in UL standards, without assuming any obligation or liability to modify any products previously manufactured, and without notice.